

Operator's manual
Manuel d'utilisation
Manual de instrucciones
525PT5S



Please read the operator's manual carefully and make sure you understand the instructions before using the machine.

Lire attentivement et bien assimiler le manuel d'utilisation avant d'utiliser la machine.

Lea detenidamente el manual de instrucciones y asegúrese de entender su contenido antes de utilizar la máquina.

English (2-30)

French (31-60)

Spanish (61-89)

KEY TO SYMBOLS

Symbols

WARNING! The machine can be a dangerous tool if used incorrectly or carelessly, which can cause serious or fatal injury to the operator or others. It is extremely important that you read and understand the contents of the operator's manual.



Please read the operator's manual carefully and make sure you understand the instructions before using the machine.



Always wear:

- Wear a protective helmet where there is a risk of falling objects
- Approved hearing protection
- Protective goggles or a visor



This machine is not electrically insulated. If the machine touches or comes close to high-voltage power lines it could lead to death or serious bodily injury. Electricity can jump from one point to another by arcing. The higher the voltage, the greater the distance electricity can jump. Electricity can also travel through branches and other objects, especially if they are wet. Always keep a distance of at least 10 m between the machine and high-voltage power lines and/or any objects that are touching them. If have to work within this safe distance you should always contact the relevant power company to make sure the power is switched off before you start work.

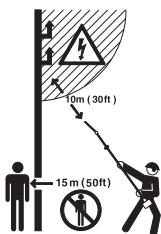

This machine has a long reach. Make sure that no people or animals come closer than 15 m when the machine is running.

Always wear approved protective gloves.



Wear sturdy, non-slip boots.



Choke control



Primer bulb

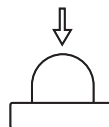

Other symbols/decals on the machine refer to special certification requirements for certain markets.

The engine is switched off by moving the stop switch to the stop position.

CAUTION! The stop switch automatically returns to the start position. In order to prevent unintentional starting, the spark plug cap must be removed from the spark plug when assembling, checking and/or performing maintenance.

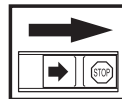

Always wear approved protective gloves.

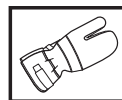

Regular cleaning is required.

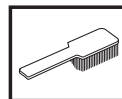

Visual check.



Protective goggles or a visor must be worn.



Filling with chain oil and adjusting oil flow



! WARNING

The engine exhaust from this product contains chemicals known to the State of California to cause cancer, birth defects or other reproductive harm.

CONTENTS

Contents

KEY TO SYMBOLS

Symbols 2

CONTENTS

Contents 3

Note the following before starting: 3

INTRODUCTION

Dear customer! 4

WHAT IS WHAT?

What is what? 5

GENERAL SAFETY PRECAUTIONS

Important 6

Personal protective equipment 6

Machine's safety equipment 7

ASSEMBLY

Fitting the cutting head 16

Fitting the bar and chain 16

Fitting the impact guard 16

Telescopic function 17

Adjusting the harness 17

FUEL HANDLING

Fuel safety 18

Fuel 18

Fueling 19

STARTING AND STOPPING

Check before starting 20

Filling with oil 20

Starting and stopping 20

WORKING TECHNIQUES

General working instructions 22

MAINTENANCE

Carburetor 25

Muffler 25

Cooling system 25

Spark plug 26

Air filter 26

Gear 26

Maintenance schedule 27

TECHNICAL DATA

Technical data 28

FEDERAL AND CALIFORNIA EMISSIONS CONTROL WARRANTY STATEMENT

YOUR WARRANTY RIGHTS AND OBLIGATIONS 29

Note the following before starting:

Please read the operator's manual carefully.

Maintenance, replacement, or repair of the emission control devices and system may be performed by any nonroad engine repair establishment or individual.



WARNING! Long-term exposure to noise can result in permanent hearing impairment. So always use approved hearing protection.



WARNING! Under no circumstances may the design of the machine be modified without the permission of the manufacturer. Always use genuine accessories. Non-authorized modifications and/or accessories can result in serious personal injury or the death of the operator or others.

Your warranty does not cover damage or liability caused by the use of non-authorized accessories or replacement parts.



WARNING! A pole saw is a dangerous tool if used carelessly or incorrectly and can cause serious, even fatal injuries. It is extremely important that you read and understand the contents of this Operator's Manual.

EMISSION CONTROL INFORMATION

 Husqvarna

HUSQVARNA AB HUSKVARNA SWEDEN

THIS ENGINE MEETS U S EPA AND CALIFORNIA EXH/EVP REGS FOR  SORE . REFER TO OPERATOR'S MANUAL FOR MAINTENANCE SPECIFICATIONS AND ADJUSTMENTS. EMISSIONS COMPLIANCE PERIOD : 

The Emissions Compliance Period referred to on the Emission Compliance label indicates the number of operating hours for which the engine has been shown to meet Federal and California emissions requirements.

INTRODUCTION

Dear customer!

Congratulations on your choice to buy a Husqvarna product! Husqvarna is based on a tradition that dates back to 1689, when the Swedish King Karl XI ordered the construction of a factory on the banks of the Huskvarna River, for production of muskets. The location was logical, since water power was harnessed from the Huskvarna River to create the water-powered plant. During over 300 years of continuous operation, the Husqvarna factory has produced a lot of different products, from wood stoves to modern kitchen appliances, sewing machines, bicycles, motorcycles etc. In 1956, the first motor driven lawn mowers appeared, followed by chain saws in 1959, and it is within this area Husqvarna is working today.

Today Husqvarna is one of the leading manufacturers in the world of forest and garden products, with quality as our highest priority. We develop, manufacture and market high quality motor driven products for forestry and gardening as well as for building and construction industry.

Your purchase gives you access to professional help with repairs and service whenever this may be necessary. If the retailer who sells your machine is not one of our authorized dealers, ask for the address of your nearest servicing dealer.

It is our wish that you will be satisfied with your product and that it will be your companion for a long time. Think of this operator's manual as a valuable document. By following its' content (using, service, maintenance etc) the life span and the second-hand value of the machine can be extended. If you ever lend or sell this machine, make sure that the borrower or buyer gets the operator's manual, so they will also know how to properly maintain and use it.

Thank you for using a Husqvarna product.

Husqvarna AB has a policy of continuous product development and therefore reserves the right to modify the design and appearance of products without prior notice.

WHAT IS WHAT?

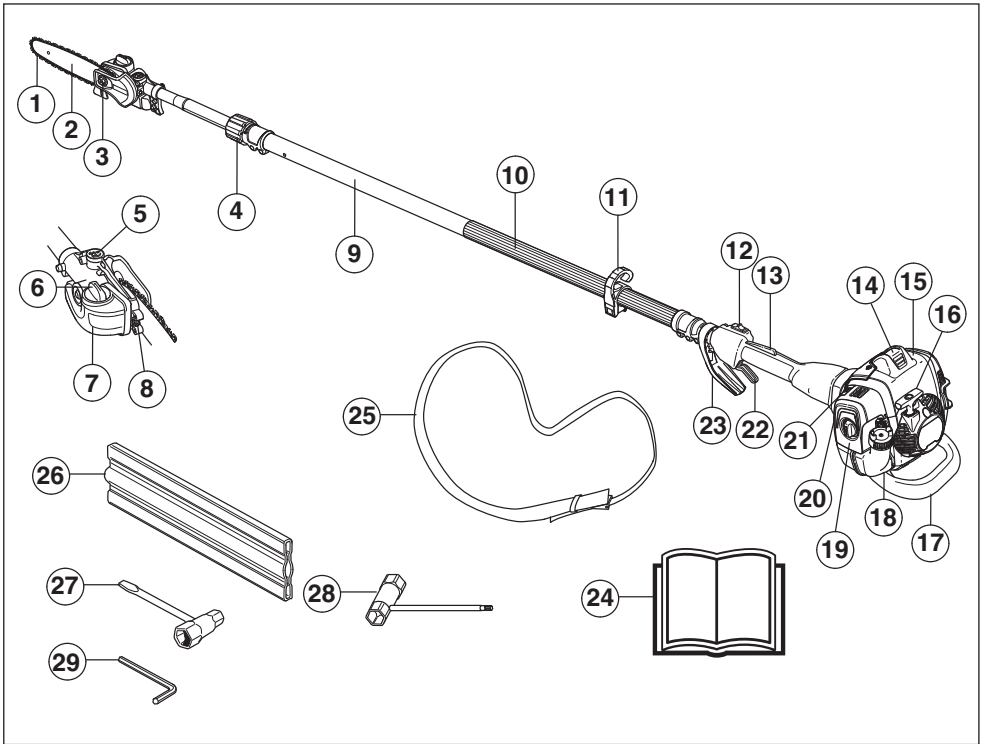

What is what?

- | | |
|--------------------------------------|--|
| 1 Saw chain | 16 Starter handle |
| 2 Guide bar | 17 Impact guard |
| 3 Bar nut | 18 Fuel tank |
| 4 Locking knob | 19 Air filter cover |
| 5 Chain lubrication adjustment screw | 20 Air purge |
| 6 Filling with chain oil | 21 Choke control |
| 7 Chain oil tank | 22 Throttle trigger |
| 8 Chain tensioning screw | 23 Throttle/hand guard |
| 9 Shaft | 24 Operator's manual |
| 10 Front handle | 25 Harness |
| 11 Harness support hook | 26 Transport guard, bar |
| 12 Stop switch | 27 Combination spanner Chain tensioner |
| 13 Throttle trigger lockout | 28 Combination spanner |
| 14 Spark plug cap and spark plug | 29 Allen key |
| 15 Cylinder cover | |

GENERAL SAFETY PRECAUTIONS

Important

IMPORTANT!

The machine is only designed for cutting branches and twigs.

National or local regulations may regulate the use. Comply to given regulations.

Never use a machine that has been modified in any way from its original specification.

Never use the machine if you are tired, if you have drunk alcohol, or if you are taking medication that could affect your vision, your judgement or your co-ordination.

Wear personal protective equipment. See instructions under the heading "Personal protective equipment".

Never use the machine in extreme weather conditions such as severe cold, very hot and/or humid climates.

Never use a machine that is faulty. Carry out the safety checks, maintenance and service instructions described in this manual. Some maintenance and service measures must be carried out by trained and qualified specialists. See instructions under the heading Maintenance.

All covers and guards must be fitted before starting. Ensure that the spark plug cap and ignition lead are undamaged to avoid the risk of electric shock.

Do an overall inspection of the machine before use, see maintenance schedule.



WARNING! This machine produces an electromagnetic field during operation. This field may under some circumstances interfere with active or passive medical implants. To reduce the risk of serious or fatal injury, we recommend persons with medical implants consult their physician and the medical implant manufacturer before operating this machine.



WARNING! Running an engine in a confined or badly ventilated area can result in death due to asphyxiation or carbon monoxide poisoning.



WARNING! Never allow children to use or be in the vicinity of the machine. As the machine is equipped with a spring-loaded stop switch and can be started by low speed and force on the starter handle, even small children under some circumstances can produce the force necessary to start the machine. This can mean a risk of serious personal injury. Therefore remove the spark plug cap when the machine is not under close supervision.

Personal protective equipment

IMPORTANT!

A pole saw is a dangerous tool if used carelessly or incorrectly and can cause serious, even fatal injuries. It is extremely important that you read and understand the contents of this Operator's Manual.

You must use approved personal protective equipment whenever you use the machine. Personal protective equipment cannot eliminate the risk of injury but it will reduce the degree of injury if an accident does happen. Ask your dealer for help in choosing the right equipment.



WARNING! Listen out for warning signals or shouts when you are wearing hearing protection. Always remove your hearing protection as soon as the engine stops.

PROTECTIVE HELMET AND VISOR

Protective helmet must be used.

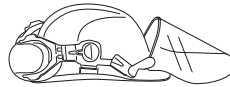

HEARING PROTECTION

Wear hearing protection that provides adequate noise reduction.

EYE PROTECTION

Protective goggles or a visor must be worn.

GLOVES

Gloves should be worn when necessary, e.g., when fitting cutting attachments.



GENERAL SAFETY PRECAUTIONS

BOOTS

Wear sturdy, non-slip boots.



CLOTHING

Wear clothes made of a strong fabric and avoid loose clothing that can catch on twigs and branches. Always wear heavy, long pants. Do not wear jewellery, shorts sandals or go barefoot. Secure hair so it is above shoulder level.

FIRST AID KIT

Always have a first aid kit nearby.



Machine's safety equipment

This section describes the machine's safety equipment, its purpose, and how checks and maintenance should be carried out to ensure that it operates correctly. See the "What is what?" section to locate where this equipment is positioned on your machine.

The life span of the machine can be reduced and the risk of accidents can increase if machine maintenance is not carried out correctly and if service and/or repairs are not carried out professionally. If you need further information please contact your nearest servicing dealer.

IMPORTANT!

All servicing and repair work on the machine requires special training. This is especially true of the machine's safety equipment. If your machine fails any of the checks described below you must contact your service agent. When you buy any of our products we guarantee the availability of professional repairs and service. If the retailer who sells your machine is not a servicing dealer, ask him for the address of your nearest service agent.



WARNING! Never use a machine with faulty safety equipment. The machine's safety equipment must be checked and maintained as described in this section. If your machine fails any of these checks contact your service agent to get it repaired.

Throttle trigger lockout

The throttle lockout is designed to prevent accidental operation of the throttle control. When you press the lock (A) (i.e. when you grasp the handle) it releases the throttle control (B). When you release the handle the throttle control and the throttle lockout both move back to their original positions. This movement is controlled by two independent return springs. This arrangement means that the throttle control is automatically locked at the idle setting.

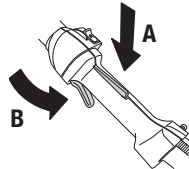

Make sure the throttle control is locked at the idle setting when the throttle lockout is released.

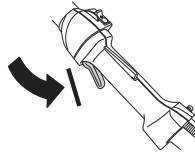

Press the throttle lockout and make sure it returns to its original position when you release it.

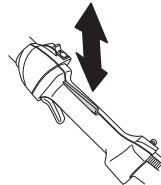

Check that the throttle trigger and throttle lockout move freely and that the return springs work properly.

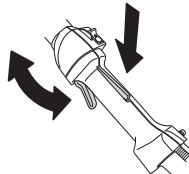

See instructions under the heading Start. Start the machine and apply full throttle. Release the throttle and check that the cutting attachment stops and remains at a standstill. If the cutting attachment rotates with the throttle in the idle position then the carburettor idle setting must

GENERAL SAFETY PRECAUTIONS

be checked. See instructions under the heading Maintenance.

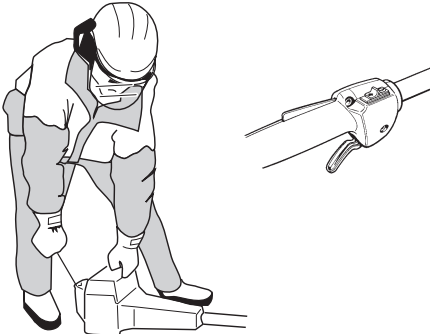

Stop switch

Use the stop switch to switch off the engine.

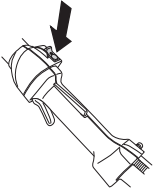

Start the engine and make sure the engine stops when you move the stop switch to the stop setting.

Vibration damping system



Your machine is equipped with a vibration damping system that is designed to reduce vibration and make operation easier.

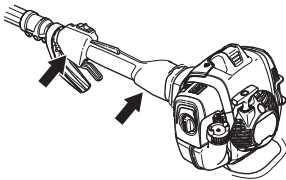

The machine's vibration damping system reduces the transfer of vibration between the engine unit/cutting equipment and the machine's handle unit.



WARNING! Overexposure to vibration can lead to circulatory damage or nerve damage in people who have impaired circulation. Contact your doctor if you experience symptoms of overexposure to vibration. Such symptoms include numbness, loss of feeling, tingling, pricking, pain, loss of strength, changes in skin colour or condition. These symptoms normally appear in the fingers, hands or wrists. The risk increases at low temperatures.

Muffler

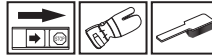

The muffler is designed to keep noise levels to a minimum and to direct exhaust fumes away from the user. A muffler fitted with a catalytic converter is also designed to reduce harmful exhaust gases.



In countries that have a warm and dry climate there is a significant risk of fire. We therefore fit certain mufflers with a spark arrestor screen. Check whether the muffler on your machine is fitted with this kind of screen.



For mufflers it is very important that you follow the instructions on checking, maintaining and servicing your machine.

GENERAL SAFETY PRECAUTIONS

Never use a machine that has a faulty muffler.

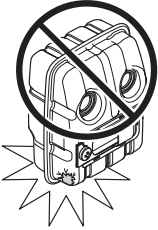

Regularly check that the muffler is securely attached to the machine.

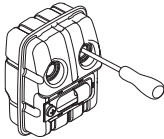

If the muffler on your machine is fitted with a spark arrestor screen this must be cleaned regularly. A blocked screen will cause the engine to overheat and may lead to serious damage.

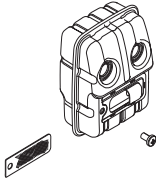

WARNING! Mufflers fitted with catalytic converters get very hot during use and remain so for some time after stopping. This also applies at idle speed. Contact can result in burns to the skin. Remember the risk of fire!



WARNING! The inside of the muffler contain chemicals that may be carcinogenic. Avoid contact with these elements in the event of a damaged muffler.



WARNING!

The exhaust fumes from the engine are hot and may contain sparks which can start a fire. Never start the machine indoors or near combustible material!

Cutting equipment



This section describes how you can achieve maximum clearing capacity and extend the life of the cutting attachment through correct maintenance and using the right type of cutting attachment.

- **Only use cutting equipment recommended by us!**

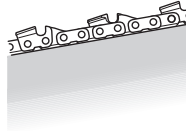

- **Keep the chain's cutting teeth properly sharpened! Follow our instructions and use the recommended file gauge.** A damaged or badly sharpened chain increases the risk of accidents.

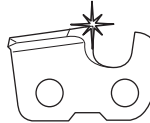

- **Maintain the correct raker clearance! Follow our instructions and use the recommended raker gauge.** Too large a clearance increases the risk of kickback.

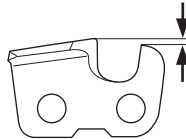

- **Keep the chain properly tensioned!** If the chain is slack it is more likely to jump off and lead to increased wear on the bar, chain and drive sprocket.



- **Keep cutting equipment well lubricated and properly maintained!** A poorly lubricated chain is more likely to break and lead to increased wear on the bar, chain and drive sprocket.



GENERAL SAFETY PRECAUTIONS



WARNING! Never use a machine with faulty safety equipment. The machine's safety equipment must be checked and maintained as described in this section. If your machine fails any of these checks contact your service agent to get it repaired.



WARNING! Always stop the engine before doing any work on the cutting attachment. This continues to rotate even after the throttle has been released. Ensure that the cutting attachment has stopped completely and disconnect the spark plug cap before you start to work on it.

Specification of bar and saw chain

When the cutting attachment supplied with your machine has to be replaced, because it is worn out or damaged, you must only fit the types of bar and saw chain recommended by us.

Guide bar

- Length (inches/cm)

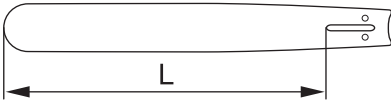

- Number of teeth on bar tip sprocket (T). Small number = small tip radius = low risk of kickback.

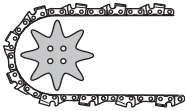

- Chain pitch (inches). The spacing between the drive links of the chain must match the spacing of the teeth on the bar tip sprocket and drive sprocket.

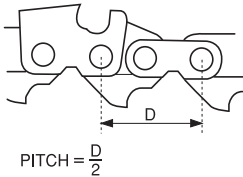

- Number of drive links. The number of drive links is determined by the length of the bar, the chain pitch and the number of teeth on the bar tip sprocket.

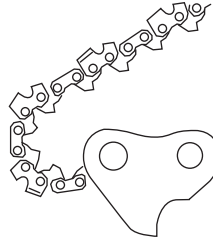

- Bar groove width (inches/mm). The groove in the bar must match the width of the chain drive links.

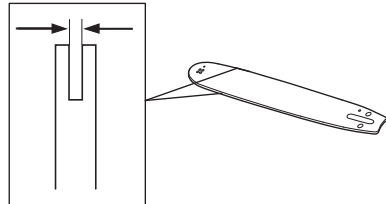

- Lubrication hole and hole for the chain tensioner.

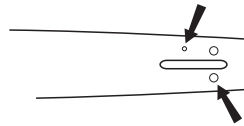

Saw chain

- Saw chain pitch (inches). (The distance between three drive links, divided by two.)

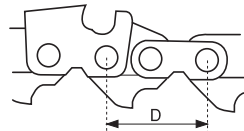

$$\text{PITCH} = \frac{D}{2}$$

- Drive link width (mm/inches)

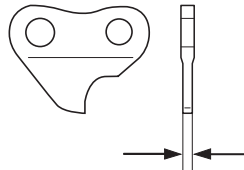

GENERAL SAFETY PRECAUTIONS

- Number of drive links.

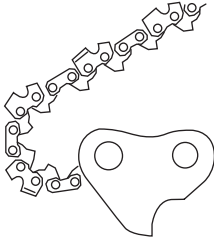

Level of kickback reduction. The only thing that describes the level of kickback reduction offered by a saw chain is its model number.

Sharpening your chain and adjusting raker clearance



WARNING! The risk of kickback is increased with a badly sharpened chain!

General information on sharpening cutting teeth



- Never use a blunt chain. When the chain is blunt you have to exert more pressure to force the bar through the wood and the cuttings will be very small. If the chain is very blunt it will not produce any cuttings at all. Wood powder would be the only result.
- A sharp chain eats its way through the wood and produces long, thick cuttings.
- The cutting part of the chain is called the cutting link and this consists of a cutting tooth (A) and the raker lip (B). The cutting depth is determined by the difference in height between the two.

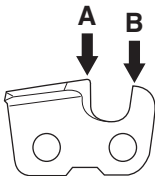

- When you sharpen a cutting tooth there are four important factors to remember.

- Filing angle

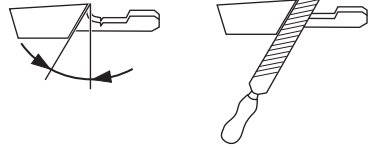

- Cutting angle



- File position

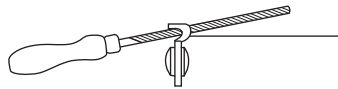

- Round file diameter

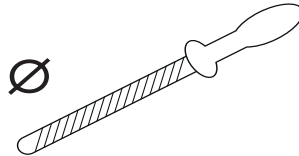

It is very difficult to sharpen a chain correctly without the right equipment. We recommend that you use our file gauge. This will help you obtain the maximum kickback reduction and cutting performance from your chain.

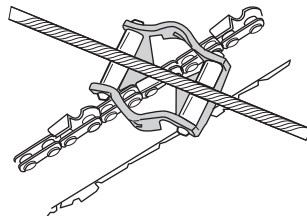

WARNING! Departure from the sharpening instructions considerably increases the risk of kickback.

GENERAL SAFETY PRECAUTIONS

Sharpening cutting teeth



To sharpen cutting teeth you will need a round file and a file gauge.

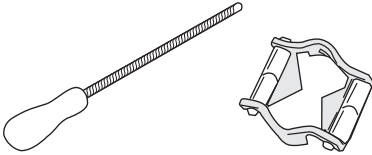

- Check that the chain is correctly tensioned. A slack chain will move sideways, making it more difficult to sharpen correctly.
- Always file cutting teeth from the inside face outwards. Reduce the pressure on the return stroke. File all the teeth on one side of the bar first. Then turn the saw over and file the remaining teeth from the other side.

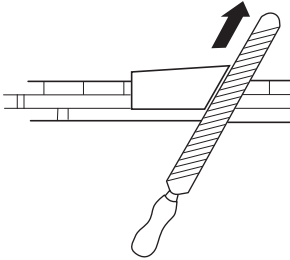

- File all the teeth to the same length. When the length of the cutting teeth is reduced to 5/32 inch (4 mm) the chain is worn out and should be replaced.

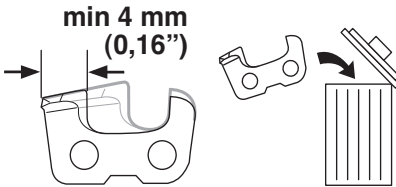

General advice on setting raker clearance



- When you sharpen the cutting teeth you reduce the raker clearance (=cutting depth). To maintain optimal cutting performance you must file back the raker lip to the recommended height.

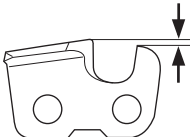

- On a low-kickback cutting link the front edge of the raker lip is rounded. It is very important that you maintain this radius or bevel when you adjust the raker clearance.

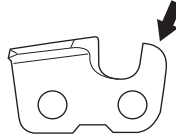

- We recommend that you use our raker gauge to achieve the correct clearance and bevel on the raker lip.

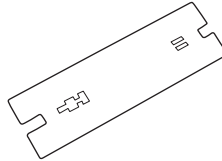

WARNING! The risk of kickback is increased if the raker clearance is too large!

Setting the raker clearance



- Before setting the raker clearance the cutting teeth should be newly sharpened.

We recommend that you adjust the raker clearance every third time you sharpen the chain. NOTE! This recommendation assumes that the length of the cutting teeth is not reduced excessively.

- To adjust the raker clearance you will need a flat file and a raker gauge.

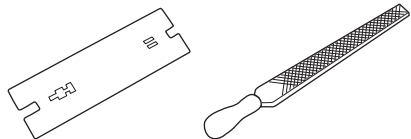

- Place the gauge over the raker lip.
- Place the file over the part of the lip that protrudes through the gauge and file off the excess. The clearance is correct when you no longer feel any resistance as you draw the file over the gauge.

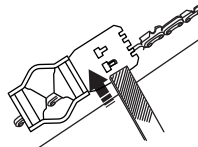

GENERAL SAFETY PRECAUTIONS

Tensioning the chain



WARNING! A slack chain may jump off the bar and cause serious or even fatal injury.

- The more you use a chain the longer it becomes. It is therefore important to adjust the chain regularly to take up the slack.
- Check the chain tension every time you refuel. NOTE! A new chain has a running-in period during which you should check the tension more frequently.
- Tension the chain as tightly as possible, but not so tight that you cannot pull it round freely by hand.

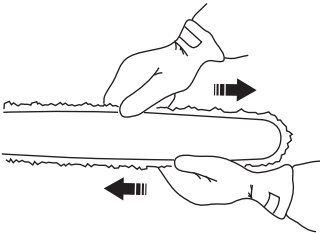

- Undo the bar nut.

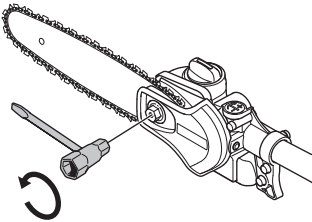

- Tension the chain by turning the chain tensioning screw clockwise using the combination spanner. The chain should be tensioned until it does not sag from the underside of the bar.

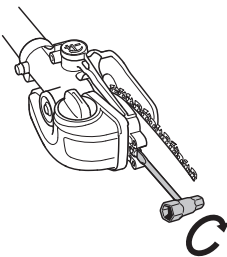

- Tighten the bar nut using the combination spanner. Check that the chain can be pulled round easily by hand.

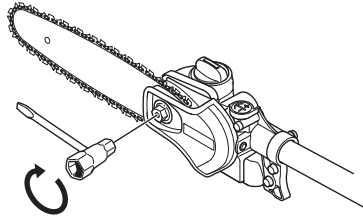

Lubricating cutting equipment



WARNING! Poor lubrication of cutting equipment may cause the chain to snap, which could lead to serious, even fatal injuries.

Chain oil

- Chain oil must demonstrate good adhesion to the chain and also maintain its flow characteristics regardless of whether it is warm summer or cold winter weather.
- As a chain saw manufacturer we have developed an optimal chain oil which has a vegetable oil base. We recommend the use of our own oil for both maximum chain life and to minimise environmental damage.
- If our own chain oil is not available, standard chain oil is recommended.
- In areas where oil specifically for lubrication of saw chains is unavailable, ordinary EP 90 transmission oil may be used.
- **Never use waste oil!** This is dangerous for yourself, the machine and the environment.

Filling with chain oil



The oil pump is preset at the factory to satisfy most lubrication requirements. A full oil tank normally lasts about the same time as a full fuel tank. Therefore check the amount of oil in the oil tank when filling the fuel to prevent damage to the saw chain and bar that may arise due to a lack of lubrication.

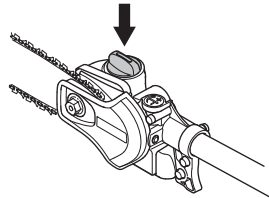

GENERAL SAFETY PRECAUTIONS

Checking chain lubrication

- Check the chain lubrication each time you refuel. Aim the tip of the bar at a light coloured surface about 20 cm (8 inches) away. After 1 minute running at 3/4 throttle you should see a distinct line of oil on the light surface.

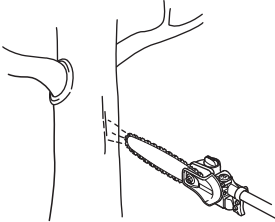

Adjusting chain lubrication

When cutting dry or hard species of wood it may be necessary to increase lubrication. Turn the adjuster screw clockwise to increase the oil flow. Remember that this will increase oil consumption, check the level in the oil tank regularly. Turn the adjuster screw anticlockwise to decrease the oil flow.

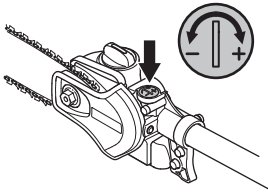

What to do if lubrication does not work:



- Check that the oil channels in the bar are not obstructed. Clean if necessary.

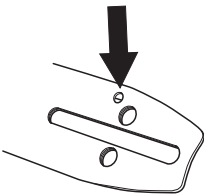

- Check that the oil channel in the gear housing is clean. Clean if necessary.
- Check that the bar tip sprocket turns freely. If the chain lubrication system is still not working after carrying out

the above checks you should contact your service workshop.

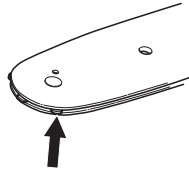

Checking wear on cutting equipment

Saw chain

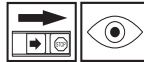

Check the chain daily for:

- Visible cracks in rivets and links.
- Whether the chain is stiff.
- Whether rivets and links are badly worn.

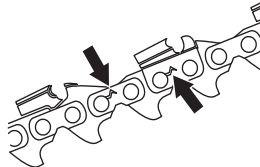

We recommend you compare the existing chain with a new chain to decide how badly the existing chain is worn.

When the length of the cutting teeth has worn down to only 5/32 inch (4 mm) the chain must be replaced.

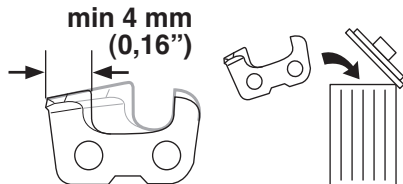

Chain drive sprocket

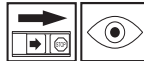

Regularly check the degree of wear on the drive sprocket. Replace if wear is excessive.

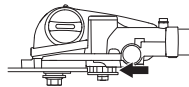

GENERAL SAFETY PRECAUTIONS

Guide bar



Check regularly:

- Whether there are burrs on the edges of the bar. Remove these with a file if necessary.

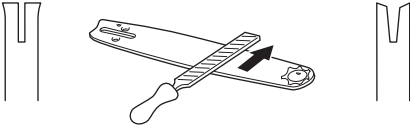

- Whether the groove in the bar is uneven or badly worn. Replace the bar if necessary.
- Whether the tip of the bar is uneven or badly worn. If a hollow forms on the underside of the bar tip this is due to running with a slack chain.

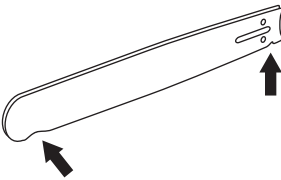

- To prolong the life of the bar you should turn it over daily.

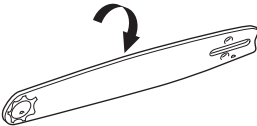

WARNING! A faulty cutting attachment may increase the risk of accidents.

ASSEMBLY

Fitting the cutting head



- Fit the cutting head on the shaft so that the screw (A) is aligned with the hole in the shaft as shown.

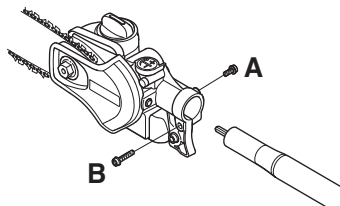

- Tighten screw A.
- Tighten screw B.

CAUTION! Make sure that the drive shaft inside the shaft engages with the cut-out in the cutting head.

Fitting the bar and chain



Unscrew the bar nut and remove the protective cover.

Fit the bar over the bar bolt. Place the bar in its rearmost position. Place the chain over the drive sprocket and in the groove on the bar. Begin on the top side of the bar.

Make sure that the edges of the cutting links are facing forward on the top edge of the bar.

Fit the cover and locate the chain adjuster pin (A) in the hole in the bar. Check that the drive links of the chain fit correctly on the drive sprocket (B) and that the chain is in the groove in the bar. Tighten the bar nut finger-tight.

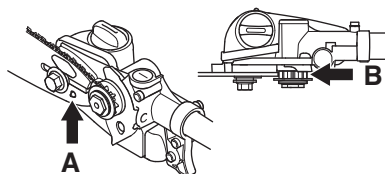

Tension the chain by turning the chain tensioning screw clockwise. Use a combination spanner or turn by hand.

The chain should be tensioned until it fits snugly on the underside of the bar.

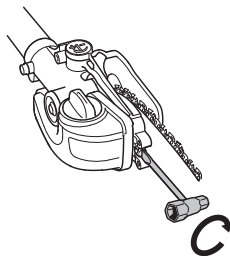

- The chain is correctly tensioned when there is no slack on the underside of the bar, and it can still be turned easily by hand. Tighten the bar nut with the combination spanner while holding up the tip of the bar.

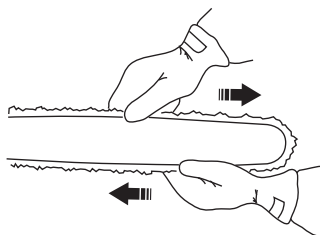

- When fitting a new chain, the chain tension has to be checked frequently until the chain is run-in. Check the chain tension regularly. A correctly tensioned chain ensures good cutting performance and long life.

Fitting the impact guard

If the machine has an impact guard bolted under the engine this should be removed before the impact guard is assembled.

Fit the guard with three screws. Tighten the screws to 4 Nm. After the machine has been in use for around 20 hours, re-tighten the screws to 4 Nm.

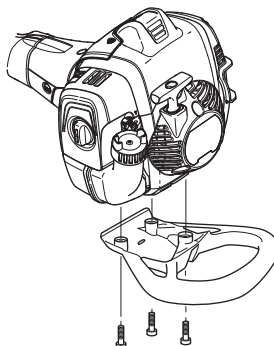

ASSEMBLY

Telescopic function



The shaft of the machine is telescopic. To change the length of the shaft, do the following:

- Undo the knob.

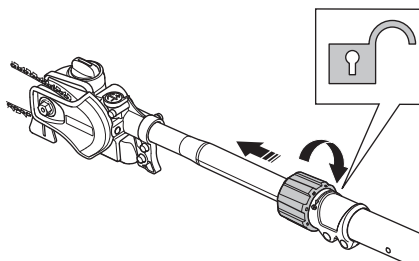

- Pull out the shaft to the desired length.
- Tighten the knob.

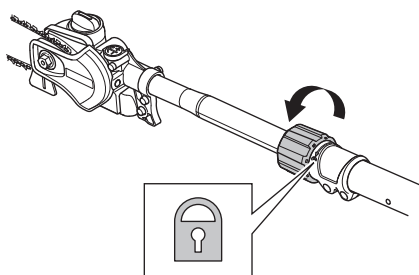

Adjusting the harness



You should always use the harness with the machine to give maximum control over the machine and reduce the risk of fatigue in your arms and back.

- Put on the harness.
- Hook the harness in one of the hooks on the machine.

- Adjust the length of the harness so that the support hook is roughly level with your right hip.



FUEL HANDLING

Fuel safety

Never start the machine:

- 1 If you have spilled fuel on it. Wipe off the spillage and allow remaining fuel to evaporate.
- 2 If you have spilled fuel on yourself or your clothes, change your clothes. Wash any part of your body that has come in contact with fuel. Use soap and water.
- 3 If the machine is leaking fuel. Check regularly for leaks from the fuel cap and fuel lines. In the event of leakage, contact your service agent.

Transport and storage

- Store and transport the machine and fuel so that there is no risk of any leakage or fumes coming into contact with sparks or open flames, for example, from electrical machinery, electric motors, electrical relays/switches or boilers.
- When storing and transporting fuel always use approved containers intended for this purpose.
- When storing the machine for long periods the fuel tank must be emptied. Contact your local gas station to find out where to dispose of excess fuel. Drain the tank into the appropriate containers and in a well ventilated area.
- Ensure the machine is cleaned and that a complete service is carried out before long-term storage.
- The transport guard must always be fitted to the cutting attachment when the machine is being transported or in storage.
- Secure the machine during transport.
- In order to prevent unintentional starting of the engine, the spark plug cap must always be removed during long-term storage, if the machine is not under close supervision and when performing all service measures.
- Allow the machine to cool before putting it in storage.



WARNING! Take care when handling fuel. Bear in mind the risk of fire, explosion and inhaling fumes.

Fuel

CAUTION! The machine is equipped with a two-stroke engine and must always be run using a mixture of gasoline and two-stroke engine oil. It is important to accurately measure the amount of oil to be mixed to ensure that the correct mixture is obtained. When mixing small amounts of fuel, even small inaccuracies can drastically affect the ratio of the mixture.



WARNING! Fuel and fuel fumes are highly inflammable and can cause serious injury when inhaled or allowed to come in contact with the skin. For this reason observe caution when handling fuel and make sure there is adequate ventilation.



WARNING! Always ensure there is adequate ventilation when handling fuel.

Gasoline



CAUTION! Always use a quality gasoline/oil mixture with an octane rating of at least 87 octane ((RON+MON)/2). If your machine is equipped with a catalytic converter (see chapter on Technical data) always use a good quality unleaded gasoline/oil mixture. Leaded gasoline will destroy the catalytic converter.

Use low-emission gasoline, also known as alkylate gasoline, if it is available.



Ethanol blended fuel, E10 may be used (max 10% ethanol blend). Using ethanol blends higher than E10 will create lean running condition which can cause engine damage.

This engine is certified to operate on unleaded gasoline.

- The lowest recommended octane grade is 87 ((RON+MON)/2). If you run the engine on a lower octane grade than 87 so-called knocking can occur. This gives rise to a high engine temperature and increased bearing load, which can result in serious engine damage.
- When working at continuous high revs a higher octane rating is recommended.

Two-stroke oil

- For best results and performance use HUSQVARNA two-stroke engine oil, which is specially formulated for our air-cooled two stroke-engines.
- Never use two-stroke oil intended for water-cooled engines, sometimes referred to as outboard oil (rated TCW).
- Never use oil intended for four-stroke engines.
- A poor oil quality and/or too high oil/fuel ratio may jeopardise function and decrease the life time of the catalytic converters.
- Mixing ratio
50:1 (2%) with HUSQVARNA two-stroke oil.

FUEL HANDLING

Gasoline, litre	Two-stroke oil, litre
	2% (50:1)
5	0,10
10	0,20
15	0,30
20	0,40
US gallon	US fl. oz.
1	2 1/2
2 1/2	6 1/2
5	12 7/8

Mixing

- Always mix the gasoline and oil in a clean container intended for fuel.
- Always start by filling half the amount of the gasoline to be used. Then add the entire amount of oil. Mix (shake) the fuel mixture. Add the remaining amount of gasoline.
- Mix (shake) the fuel mixture thoroughly before filling the machine's fuel tank.



- Do not mix more than one month's supply of fuel at a time.
- If the machine is not used for some time the fuel tank should be emptied and cleaned.



WARNING! The catalytic converter muffler gets very hot during and after use. This also applies during idling. Be aware of the fire hazard, especially when working near flammable substances and/or vapors.

Fueling



WARNING! Taking the following precautions, will lessen the risk of fire:

Mix and pour fuel outdoors, where there are no sparks or flames.

Do not smoke or place hot objects near fuel.

Always shut off the engine before refueling.

Always stop the engine and let it cool for a few minutes before refueling. Refuel in a well ventilated area. Never fuel the machine indoors.

When refuelling, open the fuel cap slowly so that any excess pressure is released gently.

Tighten the fuel cap carefully after refueling.

Always move the machine away from the refueling area and source before starting.

- Always use a fuel container with an anti-spill valve.
- If you have spilled fuel on it. Wipe off the spillage and allow remaining fuel to evaporate.
- Clean the area around the fuel cap. Contamination in the tank can cause operating problems.
- Ensure that the fuel is well mixed by shaking the container before filling the tank.

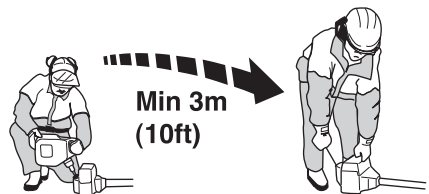

STARTING AND STOPPING

Check before starting



- Inspect the working area. Remove any objects that could be thrown out.
- Check the cutting attachment. Never use blunt, cracked or damaged equipment.
- Check that the machine is in perfect working order. Check that all nuts and screws are tight.
- Make sure the chain is adequately lubricated.
- Check that the cutting attachment always stops when the engine is idling.
- Only use the machine for the purpose it was intended for.
- Make sure that the handle and safety features are in good working order. Never use a machine that lacks a part or has been modified outside its specifications.

Filling with oil

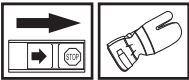

- Open the cap on top of the bar head

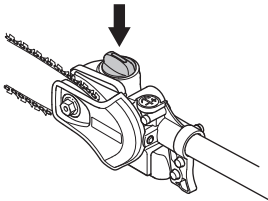

- Fill with Husqvarna saw chain oil.
- Refit the cap.

Starting and stopping



WARNING! The complete clutch cover and shaft must be fitted before the machine is started, otherwise the clutch can come loose and cause personal injury.

Always move the machine away from the refueling area and source before starting. Place the machine on a flat surface. Ensure the cutting attachment cannot come into contact with any object. Make sure no unauthorised persons are in the working area, otherwise there is a risk of serious personal injury. The safety distance is 15 meters (50 ft.).

Starting



Primer bulb: Press the air purge repeatedly until fuel begins to fill the bulb. The bulb need not be completely filled.

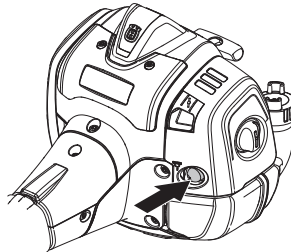

Choke: Set the choke control in the choke position.

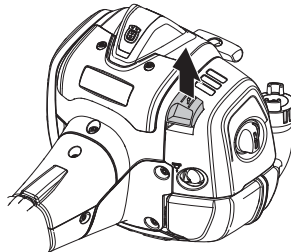

WARNING! When the engine is started with the choke in choke position the cutting attachment will start to rotate immediately.

STARTING AND STOPPING

Hold the body of the machine on the ground using your left hand (CAUTION! Not with your foot!). Grip the starter handle, slowly pull out the cord with your right hand until you feel some resistance (the starter pawls grip), now quickly and powerfully pull the cord. **Never wrap the starter cord around your hand**

Repeat pulling the cord until engine attempts to start (or maximum 5 pulls).

Move choke control down to run position.

Pull the cord until engine starts and gradually operate throttle trigger for increasing engine speed to operate speed. The throttle will automatically disengage from the start setting.

CAUTION! Do not pull the starter cord all the way out and do not let go of the starter handle when the cord is fully extended. This can damage the machine.



CAUTION! Do not put any part of your body in marked area. Contact can result in burns to the skin, or electrical shock if the spark plug cap has been damaged. Always use gloves. Do not use a machine with damaged spark plug cap.

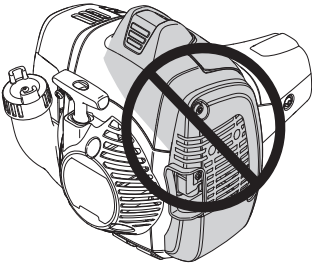

Stopping

Stop the engine by switching off the ignition.

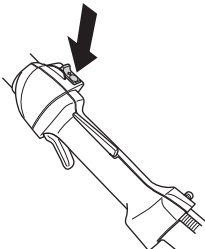

CAUTION! The stop switch automatically returns to the start position. In order to prevent unintentional starting, the spark plug cap must be removed from the spark plug when assembling, checking and/or performing maintenance.

WORKING TECHNIQUES

General working instructions

IMPORTANT!

This section takes up the basic safety precautions for working with a pole saw.

If you encounter a situation where you are uncertain how to proceed you should ask an expert. Contact your dealer or your service workshop.

Avoid all usage which you consider to be beyond your capability.



WARNING! The machine can cause serious personal injury. Read the safety instructions carefully. Learn how to use the machine.



WARNING! Cutting tool. Do not touch the tool without first switching off the engine.

Personal protection



- Always wear boots and other equipment described under the heading Personal protective equipment.
- Always wear working clothes and heavy-duty long trousers.
- Never wear loose clothing or jewellery.
- Make sure your hair does not hang below shoulder level.

Safety instructions regarding the surroundings

- Never allow children to use the machine.
- Ensure that no-one comes closer than 15 m while you are working.
- Never allow anyone else to use the machine without first ensuring that they have read and understood the contents of the operator's manual.

- Never work from a ladder, stool or any other raised position that is not fully secured.

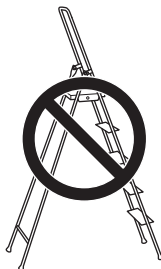

Safety instructions while working



- Always ensure you have a safe and stable working position.
- Always use both hands to hold the machine. Hold the machine at the side of your body.



- Use your right hand to control the throttle setting.
- Make sure that your hands and feet do not come near the cutting attachment when the engine is running.
- When the engine is switched off, keep your hands and feet away from the cutting attachment until it has stopped completely.
- Always lay the machine on the ground when you are not using it.
- Watch out for stumps of branches that can be thrown out during cutting.
- You should also pay attention to the fact that falling branches can bounce in the direction of the user after hitting the ground.
- Check the working area for foreign objects such as electricity cables, insects and animals, etc. or other objects that could damage the cutting attachment, such as metal items.

WORKING TECHNIQUES

- Use the harness to support the weight of the machine and make it easier to handle.



- If any foreign object is hit or if vibrations occur stop the machine immediately. Disconnect the HT lead from the spark plug. Check that the machine is not damaged. Repair any damage.
- If anything gets caught up in the cutting equipment while you are working, switch off the engine and let it stop completely and remove the ignition lead before cleaning the cutting equipment.
- This machine is not electrically insulated. If the machine touches or comes close to high-voltage power lines it could lead to death or serious bodily injury.

Safety instructions after completing work



- The transport guard should always be fitted to the cutting attachment when the machine is not in use.
- Make sure the cutting attachment has stopped before cleaning, carrying out repairs or an inspection. Disconnect the spark plug cap from the spark plug.
- Always wear heavy-duty gloves when repairing the cutting attachment. This is extremely sharp and can easily cause cuts.

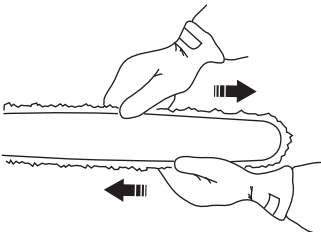

- Store the machine out of reach of children.
- Use only original spare parts for repairs.

Basic working techniques

- Hold the machine as close to your body as possible to get the best balance.



- Make sure that the tip does not touch the ground.
- Do not rush the work, but work steadily until all the branches have been cut back cleanly.
- Always slow the engine to idle speed after each working operation. Long periods at full throttle without any load on the engine can lead to serious engine damage.
- Always work at full throttle.
- Let the engine drop back to idle speed between each cut. Long periods at full throttle can cause serious damage to the centrifugal clutch.



WARNING! Never stand directly underneath a branch that is being cut. This could lead to serious or even fatal personal injury.

Observe great care when working close to overhead power lines. Falling branches can result in short-circuiting.



WARNING! Observe the applicable safety regulations for work in the vicinity of overhead power lines.

WORKING TECHNIQUES



WARNING! This machine is not electrically insulated. If the machine touches or comes close to high-voltage power lines it could lead to death or serious bodily injury. Electricity can jump from one point to another by arcing. The higher the voltage, the greater the distance electricity can jump. Electricity can also travel through branches and other objects, especially if they are wet. Always keep a distance of at least 10 m between the machine and high-voltage power lines and/or any objects that are touching them. If have to work within this safe distance you should always contact the relevant power company to make sure the power is switched off before you start work.



WARNING! This machine has a long reach. Make sure that no people or animals come closer than 15 m when the machine is running. Never swing the machine around without first checking behind you to make sure no-one is within the safety zone.

- Whenever possible position yourself so that you can make the cut at right angles to the branch.

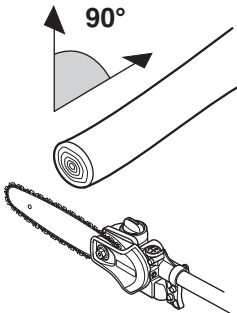

- Do not work with the shaft held straight out in front of you (like a fishing rod) as this increases the apparent weight of the cutting attachment.
- Cut large branches in sections so that you have better control over where they fall.

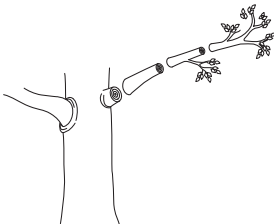

- Never cut through the swelling at the root of the branch as this will slow down healing and increase the risk of fungal attack!

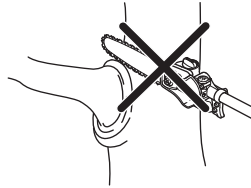

- Make an initial cut on the underside of the branch before cutting through the branch. This will prevent tearing of the bark, which could lead to slow healing and cause permanent damage to the tree. The cut should not be deeper than 1/3 of the branch thickness to prevent jamming. Keep the chain running while you withdraw the cutting attachment from the branch to prevent it jamming.

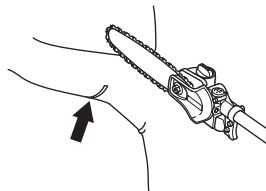

- Use the harness to support the weight of the machine and make it easier to handle.



- Make sure you have a firm footing and that you can work without being hampered by branches, stones and trees.



WARNING! Never activate the throttle without having the cutting attachment in full view.

MAINTENANCE

Carburetor

Adjustment of the idle speed

Before any adjustments are made, make sure that the air filter is clean and the air filter cover is fitted.

Adjust the idle speed using the idle adjustment screw T, if it is necessary to readjust. First turn the idle adjustment screw T clockwise until the cutting attachment starts to rotate. Then turn the screw counter clockwise until the cutting attachment stops. The idle speed is correctly adjusted when the engine will run smoothly in every position. The idle speed should also be well below the speed at which the cutting attachment starts to rotate.

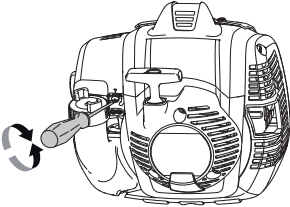

Recommended idle speed: See the Technical data section.



WARNING! If the idle speed cannot be adjusted so that the cutting attachment stops, contact your dealer/service workshop. Do not use the machine until it has been correctly adjusted or repaired.

Muffler



CAUTION! Some mufflers are fitted with a catalytic converter. See chapter on Technical data to see whether your machine is fitted with a catalytic converter.

The muffler is designed to reduce the noise level and to direct the exhaust gases away from the operator. The exhaust gases are hot and can contain sparks, which may cause fire if directed against dry and combustible material.

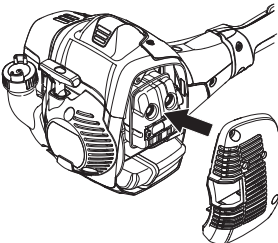

Some mufflers are equipped with a special spark arrestor screen. If your machine has this type of muffler, you should clean the screen at least once a week. This is best done with a wire brush.



On mufflers without a catalytic converter the screen should be cleaned weekly, or replaced if necessary. On mufflers fitted with a catalytic converter the screen should be checked, and if necessary cleaned, monthly. **If the screen is damaged it should be replaced.**

If the screen is frequently blocked, this can be a sign that the performance of the catalytic converter is impaired. Contact your dealer to inspect the muffler. A blocked screen will cause the machine to overheat and result in damage to the cylinder and piston. See instructions under the heading Maintenance.

CAUTION! Never use a machine with a defective muffler.



WARNING! Mufflers fitted with catalytic converters get very hot during use and remain so for some time after stopping. This also applies at idle speed. Contact can result in burns to the skin. Remember the risk of fire!

Cooling system

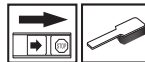

To keep the working temperature as low as possible the machine is equipped with a cooling system.

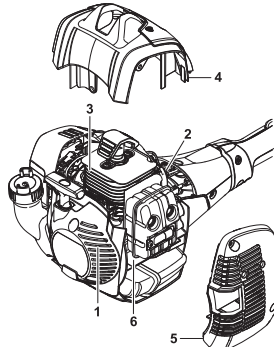

The cooling system consists of:

- 1 Air intake on the starter.

MAINTENANCE

- 2 Fins on the flywheel.
- 3 Cooling fins on the cylinder.
- 4 Cylinder cover (directs cold air over the cylinder).

Clean the cooling system with a brush once a week, more often in demanding conditions. A dirty or blocked cooling system results in the machine overheating which causes damage to the piston and cylinder.

Spark plug



The spark plug condition is influenced by:

- Incorrect carburetor adjustment.
- An incorrect fuel mixture (too much or incorrect type of oil).
- A dirty air filter.

These factors cause deposits on the spark plug electrodes, which may result in operating problems and starting difficulties.

If the machine is low on power, difficult to start or runs poorly at idle speed: always check the spark plug first before taking any further action. If the spark plug is dirty, clean it and check that the electrode gap is 0.026 inch (0.65 mm). The spark plug should be replaced after about a month in operation or earlier if necessary.

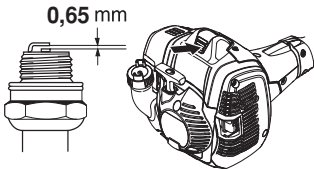

CAUTION! Always use the recommended spark plug type! Use of the wrong spark plug can damage the piston/ cylinder. Check that the spark plug is fitted with a suppressor.

Air filter



The air filter must be regularly cleaned to remove dust and dirt in order to avoid:

- Carburettor malfunctions.
- Starting problems.
- Loss of engine power.
- Unnecessary wear to engine parts
- Excessive fuel consumption.

Clean the filter every 25 hours, or more regularly if conditions are exceptionally dusty.

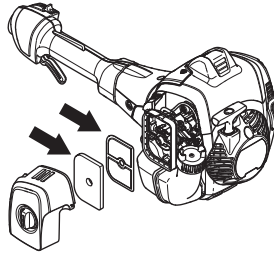

Cleaning the air filter

Close the choke valve by moving the choke control up.

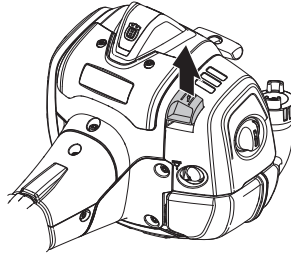

Remove the air filter cover and take out the filter. Wash it clean in warm, soapy water.

IMPORTANT! Use only HUSQVARNA replacement parts. Use of other brands of replacement parts can cause damage to your unit or injury to the operator or others. Your warranty does not cover damage or liability caused by the use of accessories and/or attachments not specifically recommended by HUSQVARNA.

Gear

IMPORTANT!

All service on the saw head must be carried out by an authorized Husqvarna dealer.

Always use Husqvarna's original grease to prevent damage to the gear in the saw head.

Use grease with part number: 579 06 49-01

MAINTENANCE

Maintenance schedule

The following is a list of the maintenance that must be performed on the machine. Most of the items are described in the Maintenance section. The user must only carry out the maintenance and service work described in this manual. More extensive work must be carried out by an authorized service workshop.

Maintenance	Daily Maintenance	Weekly maintenance	Monthly maintenance
Clean the outside of the machine.	X		
Make sure the throttle trigger lock and the throttle function correctly from a safety point of view.	X		
Check that the stop switch works correctly.	X		
Check that the cutting attachment does not rotate at idle.	X		
Clean the air filter. Replace if necessary.	X		
Check that nuts and screws are tight.	X		
Check that there are no fuel leaks from the engine, tank or fuel lines.	X		
Clean the area under the protective cover.	X		
Check the saw chain with regard to visible cracks in the rivets and links, whether the saw chain is stiff or whether the rivets and links are abnormally worn.	X		
Check the starter and starter cord.		X	
Check that the vibration damping elements are not damaged.		X	
Clean the outside of the spark plug. Remove it and check the electrode gap. Adjust the gap to 0.65 mm (.026"), or replace the spark plug. Check that the spark plug is fitted with a suppressor.		X	
Clean the machine's cooling system.		X	
Clean or replace the spark arrestor screen on the muffler (only applies to mufflers without a catalytic converter).		X	
Clean the outside of the carburettor and the space around it.		X	
File off any burrs from the edges of the bar.		X	
Clean the fuel tank.			X
Check the fuel filter for contamination and the fuel hose for cracks or other defects. Replace if necessary.			X
Check all cables and connections.			X
Check the clutch, clutch springs and the clutch drum for wear. Replace if necessary by an authorized service workshop.			X
Replace the spark plug. Check that the spark plug is fitted with a suppressor.			X
Check and clean the spark arrestor screen on the muffler (only applies to mufflers fitted with a catalytic converter).			X

TECHNICAL DATA

Technical data

525PT5S

Engine

Cylinder displacement, cu.in/cm ³	1,55/25,4
Cylinder bore, inch/mm	1,34/34
Stroke, inch/mm	1,10/28
Recommended max. speed, rpm	11000-12000
Idle speed, rpm	2800-3000
Max. engine output, acc. to ISO 8893, kW/ rpm	1.0/8500
Catalytic converter muffler	Yes
Speed-regulated ignition system	Yes

Ignition system

Spark plug	NGK BPMR8Y
Electrode gap, inch/mm	0.02/0,5

Fuel and lubrication system

Fuel tank capacity, US pint/litre	1,06/0,5
Oil tank capacity, US pint/litre	0,30/0,14

Weight

Weight without fuel, oil and cutting equipment, kg	16/7,2
--	--------

Sound levels

(see note 1)

Equivalent sound pressure level at the operator's ear, measured according to ISO 22868, dB(A): 89

Vibration levels

(see note 2)

Vibration levels at handles, measured according to EN ISO 22867, m/s²





Short shaft front/rear handle	6,3/5,3
Extended shaft front/rear handle	4,1/6,7

Note 1: Reported data for equivalent sound pressure level for the machine has a typical statistical dispersion (standard deviation) of 1 dB (A).

Note 2: Reported data for equivalent vibration level has a typical statistical dispersion (standard deviation) of 1 m/s².

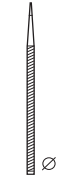
Guide bar and saw chain combinations

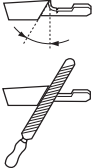
Guide bar			Saw chain	
Length, inch	Pitch, inch/mm	Gauge, inch	Type	Drive link count
12	3/8	0.050	H35	44

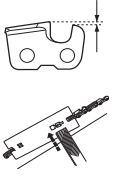
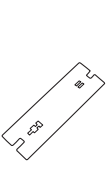
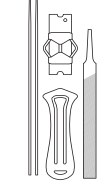
							
35	inch/mm 5/32 / 4,0	80°	30°	0°	inch/mm 0.025/0.65	—————	5796536-01

FEDERAL AND CALIFORNIA EMISSIONS CONTROL WARRANTY STATEMENT

IMPORTANT: This product is compliant with U.S. EPA Phase 3 regulations for exhaust and evaporative emissions. To ensure EPA Phase 3 compliance, we recommend using only genuine Husqvarna brand replacement parts. Use of non-compliant replacement parts is a violation of federal law.

YOUR WARRANTY RIGHTS AND OBLIGATIONS

The EPA (U.S. Environmental Protection Agency), CARB (California Air Resources Board), Environment Canada and Husqvarna Forest & Garden are pleased to explain the emissions control system's warranty on your 2015-2016* small off-road engine. In U.S. and Canada, new equipment that use small off-road engines must be designed, built, and equipped to meet the applicable Federal or Californian stringent anti-smog standards. Husqvarna Forest & Garden must warrant the emissions control system on your small off-road engine for the period of time listed below provided there has been no abuse, neglect or improper maintenance of your small off-road engine. Your emission control system may include parts such as the carburetor, fuel-injection system, the ignition system, catalytic converter, fuel tanks, fuel lines, fuel caps, valves, canisters, filters, vapor hoses, clamps, connectors, and other associated emission-related components. Also, included may be hoses, belts, connectors, sensors, and other emission-related assemblies. Where a warrantable condition exists, Husqvarna Forest & Garden will repair your small off-road engine at no cost to you including diagnosis, parts and labor.

MANUFACTURER'S WARRANTY COVERAGE

The emissions control system is warranted for two years. If any emissions-related part on your small off-road engine is defective, the part will be repaired or replaced by Husqvarna Forest & Garden.

OWNER'S WARRANTY RESPONSIBILITIES

- As the small off-road engine owner, you are responsible for performance of the required maintenance listed in your operator's manual. Husqvarna Forest & Garden recommends that you retain all receipts covering maintenance on your small off-road engine, but Husqvarna Forest & Garden cannot deny warranty solely for the lack of receipts or your failure to ensure the performance of all scheduled maintenance.
- As the small off-road engine owner, you should however be aware that Husqvarna Forest & Garden may deny you warranty coverage if your small off-road engine or a part has failed due to abuse, neglect, or improper maintenance or unapproved modifications.

- You are responsible for presenting your small off-road engine to a Husqvarna Forest & Garden distribution center or service center as soon as the problem exists. The warranty repairs should be completed in a reasonable amount of time, not to exceed 30 days.

If you have any questions regarding your warranty coverage, you should contact Husqvarna Forest & Garden in USA at 1-800-487-5951, in CANADA at 1-800-805-5523 or send e-mail correspondence to emissions@husqvarnagroup.com.

WARRANTY COMMENCEMENT DATE

The warranty period begins on the date the engine or equipment is delivered to an ultimate purchaser.

LENGTH OF COVERAGE

Husqvarna Forest & Garden warrants to the ultimate purchaser and each subsequent owner that the engine or equipment is designed, built, and equipped so as to conform with all applicable regulations adopted by EPA and CARB, and is free from defects in materials and workmanship that causes the failure of a warranted part for a period of two years.

WHAT IS COVERED

REPAIR OR REPLACEMENT OF PARTS Repair or replacement of any warranted part under the warranty must be performed at no charge to the owner at a warranty station. Warranty services or repairs will be provided at all Husqvarna Forest & Garden distribution centers that are franchised to service the subject engines. Throughout the emissions warranty period of two years, Husqvarna Forest & Garden must maintain a supply of warranted parts sufficient to meet the expected demand for such parts.

WARRANTY PERIOD Any warranted part that is scheduled for replacement as required in the maintenance schedule, is warranted for the period of time prior to the first scheduled replacement point for that part. If the part fails prior to the first scheduled replacement, the part will be repaired or replaced by Husqvarna Forest & Garden at no cost. Any such part repaired or replaced under warranty is warranted for the remainder of the period prior to the first scheduled replacement point for the part. Any warranted part that is not scheduled for replacement as required in the maintenance schedule, is warranted for two years. If any such part fails during the period of warranty coverage, it will be repaired and replaced by Husqvarna Forest & Garden at no cost. Any such part repaired or replaced under the warranty is warranted for the remaining warranty period. Any warranted part that is scheduled only for regular inspection in the maintenance schedule will be warranted for a period of two years. A statement in such written instructions to the effect of "repair or replace as necessary" will not reduce the period of warranty coverage. Any such part repaired or replaced under warranty will be warranted for the remaining warranty period.

FEDERAL AND CALIFORNIA EMISSIONS CONTROL WARRANTY STATEMENT

DIAGNOSIS The owner must not be charged for diagnostic labor that leads to the determination that a warranted part is in fact defective, provided that such diagnostic work is performed at a warranty station.

CONSEQUENTIAL DAMAGES Husqvarna Forest & Garden is liable for damages to other engine components proximately caused by a failure under warranty of any warranted part.

EMISSION WARRANTY PARTS LIST

- 1 Carburetor and internal parts
- 2 Intake pipe, airfilter holder and carburetor bolts.
- 3 Airfilter and fuelfilter covered up to maintenance schedule.
- 4 Spark Plug, covered up to maintenance schedule
- 5 Ignition Module
- 6 Fuel tank, line and cap

WHAT IS NOT COVERED

All failures caused by abuse, neglect or improper maintenance are not covered.

ADD -ON OR MODIFIED PARTS

Add-on or modified parts that are not exempted by CARB or EPA may not be used. The use of any non-exempted add-on or modified parts will be grounds for disallowing a warranty claim. Husqvarna Forest & Garden will not be liable to warrant failures of warranted parts caused by the use of a non-exempted add-on or modified part.

HOW TO FILE A CLAIM

If you have any questions regarding your warranty rights and responsibilities, you should contact your nearest authorized servicing dealer or call Husqvarna Forest & Garden in USA at 1-800-487-5951, in CANADA at 1-800-805-5523 or send e-mail correspondence to emissions@husqvarnagroup.com.

WHERE TO GET WARRANTY SERVICE

Warranty services or repairs are provided through all Husqvarna Forest & Garden authorized servicing dealers.

MAINTENANCE, REPLACEMENT AND REPAIR OF EMISSION-RELATED PARTS

Any replacement part may be used in the performance of any warranty maintenance or repairs and must be provided without charge to the owner. Such use will not reduce the warranty obligations of the manufacturer.

MAINTENANCE STATEMENT

The owner is responsible for the performance of all required maintenance, as defined in the operator's manual.

*Current and following model year will be updated annually in the warranty statement provided to the consumer. For example, in 2012 model year, 2012-2013 will be specified.

EXPLICATION DES SYMBOLES

Symboles

AVERTISSEMENT! La machine utilisée de manière imprudente ou inadéquate peut devenir un outil dangereux, pouvant causer des blessures graves voire mortelles à l'utilisateur et aux autres personnes présentes. Il est extrêmement important de lire et de comprendre le contenu de ce manuel de l'opérateur.



Lire attentivement et bien assimiler le manuel d'utilisation avant d'utiliser la machine.



Toujours utiliser:

- Portez un casque de protection là où il y a risque de chute d'objets
- Protecteurs d'oreilles homologués
- Lunettes protectrices ou visière



Cette machine ne comporte pas d'isolation électrique. Si la machine entre en contact avec ou est utilisée à proximité de lignes conductrices de tension, ceci peut résulter en des blessures personnelles graves voire mortelles. L'électricité peut être transmise d'un point à un autre par un arc de tension. Plus la tension est élevée et plus la longueur de transmission de la tension est élevée. L'électricité peut également être transmise par des branches et d'autres objets, particulièrement s'ils sont mouillés. Toujours conserver une distance d'au moins 10 mètres entre la machine et la ligne conductrice d'électricité et/ou les objets en contact avec cette ligne. S'il est nécessaire que le travail soit effectué avec des distances de sécurité plus courtes, toujours contacter la compagnie électrique afin de s'assurer que la tension a bien été coupée avant de commencer les travaux.

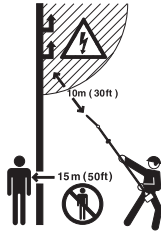

La machine a une longue portée. Vérifier qu'aucune personne et qu'aucun animal ne se trouvent à moins de 15 mètres quand la machine est utilisée.

Toujours porter des gants de protection homologués.



Utiliser des bottes antidérapantes et stables.



Commande de starter



Pompe à carburant

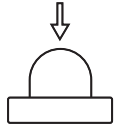

Les autres symboles/autocollants présents sur la machine concernent des exigences de certification spécifiques à certains marchés.

Arrêter le moteur en déplaçant l'interrupteur d'arrêt en position d'arrêt. **REMARQUE!** L'interrupteur d'arrêt se remet automatiquement en position de démarrage. Toujours retirer le chapeau de bougie de la bougie lors du montage, contrôle et/ou entretien, afin d'éviter tout démarrage accidentel.

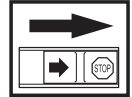

Toujours porter des gants de protection homologués.



Un nettoyage régulier est indispensable.

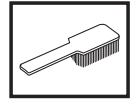

Examen visuel.



Porter des lunettes protectrices ou une visière.



Remplissage d'huile et réglage du débit d'huile.



ATTENTION!

Les émissions du moteur de cet outil contiennent des produits chimiques qui, d'après l'État de Californie, peuvent causer le cancer, des malformations congénitales ou autre danger pour la reproduction.

SOMMAIRE

Sommaire

EXPLICATION DES SYMBOLES

Symboles 31

SOMMAIRE

Sommaire 32

Contrôler les points suivants avant la mise en marche: 32

INTRODUCTION

Cher client, 33

QUELS SONT LES COMPOSANTS?

Quels sont les composants? 34

INSTRUCTIONS GÉNÉRALES DE SÉCURITÉ

Important! 35

Équipement de protection personnelle 35

Équipement de sécurité de la machine 36

MONTAGE

Montage de la tête de coupe 45

Montage du guide-chaîne et de la chaîne 45

Montage de la protection antichocs 45

Fonction télescopique 46

Réglage du harnais 46

MANIPULATION DU CARBURANT

Sécurité carburant 47

Carburant 47

Remplissage de carburant 48

DÉMARRAGE ET ARRÊT

Contrôles avant la mise en marche 49

Remplissage d'huile 49

Démarrage et arrêt 49

TECHNIQUES DE TRAVAIL

Méthodes de travail 51

ENTRETIEN

Carburateur 54

Silencieux 54

Système de refroidissement 55

Bougie 55

Filtre à air 55

Engrenage 56

Schéma d'entretien 57

CARACTÉRISTIQUES TECHNIQUES

Caractéristiques techniques 58

DÉCLARATION DE GARANTIE CONTRÔLE DES ÉMISSIONS EN CALIFORNIE ET AU NIVEAU FÉDÉRAL

VOS DROITS ET OBLIGATIONS EN GARANTIE 59

Contrôler les points suivants avant la mise en marche:

Lire attentivement le manuel d'utilisation.

L'entretien, le remplacement ou la réparation des dispositifs et des systèmes antipollution peuvent être effectués par tout établissement ou personne qui répare des produits motorisés manuels.



AVERTISSEMENT! Une exposition prolongée au bruit risque de causer des lésions auditives permanentes. Toujours utiliser des protecteurs d'oreille agréés.



AVERTISSEMENT! Ne jamais modifier sous aucun prétexte la machine sans l'autorisation du fabricant. N'utiliser que des accessoires et des pièces d'origine. Des modifications non-autorisées et l'emploi d'accessoires non-homologués peuvent provoquer des accidents graves et même mortels, à l'utilisateur ou d'autres personnes.



AVERTISSEMENT! Une tronçonneuse à perche utilisée de manière erronée ou négligente peut être un outil dangereux pouvant occasionner des blessures personnelles graves, voire mortelles. Il importe donc de lire attentivement et de bien assimiler le contenu de ce manuel d'utilisation.

EMISSION CONTROL INFORMATION



HUSQVARNA
HUSQVARNA AB HUSKVARNA SWEDEN

THIS ENGINE MEETS U.S. EPA AND CALIFORNIA
EXH/EVP REGS FOR [REDACTED] SORE. REFER TO OPERATOR'S
MANUAL FOR MAINTENANCE SPECIFICATIONS AND
ADJUSTMENTS. EMISSIONS COMPLIANCE PERIOD: [REDACTED]

La période de conformité des émissions à laquelle il est fait référence sur l'étiquette de conformité des émissions indique le nombre d'heures de fonctionnement pour lesquelles il a été établi que le moteur répond aux exigences californiennes et fédérales en matière d'émissions.

INTRODUCTION

Cher client,

Félicitations pour ce choix d'un produit Husqvarna. Husqvarna a vu le jour en 1689 lorsque le roi Karl XI décida de construire un arsenal pour la fabrication des mousquets au bord de la rivière Huskvarna. Le choix de l'emplacement était logique puisque la rivière Huskvarna servait à produire de l'énergie hydraulique et constituait donc une sorte de centrale hydraulique. En plus de 300 ans d'existence, l'usine Husqvarna a fabriqué de nombreux produits, depuis les cuisinières à bois jusqu'aux équipements de cuisine modernes, sans oublier les machines à coudre, les bicyclettes, les motos, etc. La première tondeuse à moteur a été lancée en 1956, suivie en 1959 de la première tronçonneuse. C'est dans ce secteur que Husqvarna est actif aujourd'hui.

Husqvarna est aujourd'hui un des plus grands fabricants du monde de produits destinés à l'entretien des forêts et des jardins. La qualité et les performances sont nos priorités. Notre concept d'affaires est de développer, fabriquer et commercialiser des produits à moteur pour l'entretien des forêts et des jardins et pour les entreprises de construction et d'aménagement des sols. L'objectif d'Husqvarna est aussi d'être à la pointe du progrès en matière d'ergonomie, de facilité d'utilisation, de sécurité et de protection de l'environnement; un grand nombre d'innovations ont été développées pour améliorer les produits dans ces domaines.

Nous sommes persuadés que vous apprécierez la qualité et les performances de nos produits pendant de longues années. L'achat d'un de nos produits vous garantit une assistance professionnelle au niveau du service et des réparations en cas de besoin. Si la machine n'a pas été achetée chez un de nos revendeurs autorisés, demandez à un revendeur l'adresse de l'atelier d'entretien le plus proche.

Nous espérons que cette machine vous donnera toute satisfaction et qu'elle vous accompagnera pendant de longues années. N'oubliez pas que ce manuel d'utilisation est important. En suivant les instructions qu'il contient (utilisation, révision, entretien, etc.), il est possible d'allonger considérablement la durée de vie de la machine et d'augmenter sa valeur sur le marché de l'occasion. En cas de vente de la machine, ne pas oublier de remettre le manuel d'utilisation au nouveau propriétaire.

Nous vous remercions d'utiliser un produit Husqvarna !

Husqvarna AB travaille continuellement au développement de ses produits et se réserve le droit d'en modifier, entre autres, la conception et l'aspect sans préavis.

QUELS SONT LES COMPOSANTS?

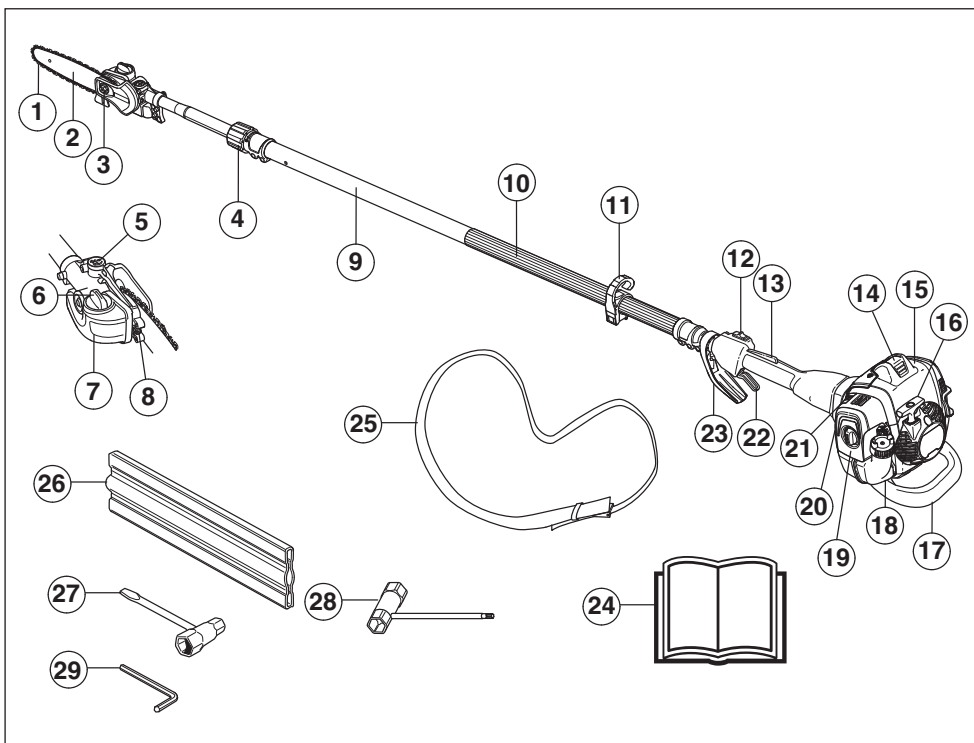

Quels sont les composants?

- | | |
|---|---|
| 1 Chaîne | 16 Poignée de lanceur |
| 2 Guide-chaîne | 17 Protection anti-chocs |
| 3 Ecrou du guide-chaîne | 18 Réservoir d'essence |
| 4 Manette de verrouillage | 19 Carter de filtre à air |
| 5 Vis de réglage lubrification de la chaîne | 20 Pompe à carburant |
| 6 Remplissage d'huile de chaîne | 21 Commande de starter |
| 7 Réservoir d'huile de chaîne | 22 Commande de l'accélération |
| 8 Vis de tendeur de chaîne | 23 Accélération/Protège-main |
| 9 Tube de transmission | 24 Manuel d'utilisation |
| 10 Poignée avant | 25 Harnais |
| 11 Crochet de suspension du harnais | 26 Protection pour le transport, guide-chaîne |
| 12 Bouton d'arrêt | 27 Clé universelle Tendeur de chaîne |
| 13 Blocage de l'accélération | 28 Clé universelle |
| 14 Chapeau de bougie et bougie | 29 Clé à six pans |
| 15 Capot de cylindre | |

INSTRUCTIONS GÉNÉRALES DE SÉCURITÉ

Important!

IMPORTANT!

La machine est uniquement construite pour le sciage des branches et rameaux.

La législation nationale ou locale peut réglementer l'utilisation. Respectez la législation en vigueur.

Ne jamais utiliser une machine qui a été modifiée au point de ne plus être conforme au modèle original.

Éviter d'utiliser la machine en cas de fatigue, d'absorption d'alcool ou de prise de médicaments susceptibles d'affecter l'acuité visuelle, le jugement ou la maîtrise du corps.

Utiliser les équipements de protection personnelle. Voir au chapitre "Équipement de protection personnelle".

Ne jamais utiliser la machine dans des conditions climatiques extrêmes telles que la froid intense ou climat très chaud et/ou humide.

Ne jamais utiliser une machine qui n'est pas en parfait état de marche. Appliquer les instructions de maintenance et d'entretien ainsi que les contrôles de sécurité indiqués dans ce manuel d'utilisation. Certaines mesures de maintenance et d'entretien doivent être confiées à un spécialiste dûment formé et qualifié. Voir les instructions à la section Maintenance.

Tous les carters et toutes les protections doivent être montés avant le démarrage. Vérifier que le chapeau de bougie et le câble d'allumage ne sont pas endommagés afin d'éviter tout risque de choc électrique.

Effectuez une inspection générale de la machine avant de l'utiliser, voir le Calendrier de maintenance.



AVERTISSEMENT! Cette machine génère un champ électromagnétique en fonctionnement. Ce champ peut dans certaines circonstances perturber le fonctionnement d'implants médicaux actifs ou passifs. Pour réduire le risque de blessures graves ou mortelles, les personnes portant des implants médicaux doivent consulter leur médecin et le fabricant de leur implant avant d'utiliser cette machine.



AVERTISSEMENT! Faire tourner un moteur dans un local fermé ou mal aéré peut causer la mort par asphyxie ou empoisonnement au monoxyde de carbone.



AVERTISSEMENT! Ne jamais laisser des enfants utiliser la machine ou se tenir à proximité. La machine est équipée d'un interrupteur d'arrêt à détente et peut être démarrée par une activation à faible vitesse et de faible puissance de la poignée de démarrage ; dans certaines circonstances, de jeunes enfants peuvent produire la force nécessaire au démarrage de la machine. Ceci peut entraîner un risque de blessures personnelles. Retirer donc le chapeau de bougie lorsque la machine n'est pas sous surveillance.

Équipement de protection personnelle

IMPORTANT!

Une tronçonneuse à perche utilisée de manière erronée ou négligente peut être un outil dangereux pouvant occasionner des blessures personnelles graves, voire mortelles. Il importe donc de lire attentivement et de bien assimiler le contenu de ce manuel d'utilisation.

Un équipement de protection personnelle homologué doit impérativement être utilisé lors de tout travail avec la machine. L'équipement de protection personnelle n'élimine pas les risques mais réduit la gravité des blessures en cas d'accident. Demander conseil au concessionnaire afin de choisir un équipement adéquat.



AVERTISSEMENT! Soyez toujours attentifs aux signaux d'alerte ou aux appels en portant des protège-oreilles. Enlevez-les sitôt le moteur arrêté.

CASQUE DE PROTECTION AVEC VISIÈRE

Il faut utiliser un casque de protection.

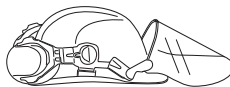

PROTÈGE-OREILLES

Porter des protège-oreilles ayant un effet atténuateur suffisant.

PROTÈGE-YEUX

Porter des lunettes protectrices ou une visière.

GANTS

Au besoin, utiliser des gants, notamment lors du montage de l'équipement de coupe.



INSTRUCTIONS GÉNÉRALES DE SÉCURITÉ

BOTTES

Utiliser des bottes antidérapantes et stables.



HABITS

Porter des vêtements fabriqués dans un matériau résistant à la déchirure, éviter les vêtements excessivement amples qui risqueraient de se prendre dans les broussailles et les branches. Toujours utiliser des pantalons longs et robustes. Ne pas porter de bijoux, de shorts ou de sandales, et ne pas marcher pieds-nus. Veiller à ce que les cheveux ne tombent pas sur les épaules.

PREMIERS SECOURS

Une trousse de premiers secours doit toujours être disponible.



Équipement de sécurité de la machine

Ce chapitre présente les équipements de sécurité de la machine, leur fonction, comment les utiliser et les maintenir en bon état. Voir au chapitre Quels sont les composants? pour trouver leur emplacement sur la machine.

La durée de vie de la machine risque d'être écourtée et le risque d'accidents accru si la maintenance de la machine n'est pas effectuée correctement et si les mesures d'entretien et/ou de réparation ne sont pas effectuées de manière professionnelle. Pour obtenir de plus amples informations, contacter l'atelier de réparation le plus proche.

IMPORTANT!

L'entretien et la réparation de la machine exigent une formation spéciale. Ceci concerne particulièrement l'équipement de sécurité de la machine. Si les contrôles suivants ne donnent pas un résultat positif, s'adresser à un atelier spécialisé. L'achat de l'un de nos produits offre à l'acheteur la garantie d'un service et de réparations qualifiés. Si le point de vente n'assure pas ce service, s'adresser à l'atelier spécialisé le plus proche.



AVERTISSEMENT! Ne jamais utiliser une machine dont les équipements de sécurité sont défectueux. Contrôler et entretenir les équipements de sécurité de la machine conformément aux instructions données dans ce chapitre. Si les contrôles ne donnent pas de résultat positif, confier la machine à un atelier spécialisé.

Blocage de l'accélération

Le blocage de l'accélération a pour but d'empêcher toute accélération involontaire. Une fois le cliquet (A) enfoncé dans la poignée (= en tenant celle-ci), la commande de l'accélération (B) se trouve libérée. Quand la poignée est relâchée, la commande de l'accélération et le cliquet reviennent en position initiale. Ce retour en position initiale s'effectue grâce à deux ressorts de rappel indépendants. Cette position signifie que la commande d'accélération est alors automatiquement bloquée sur le ralenti.

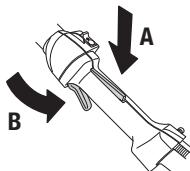

Vérifier d'abord que la commande de l'accélération est bloquée en position de ralenti quand le blocage de l'accélération est en position initiale.

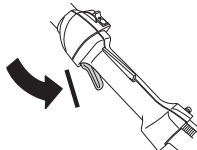

Appuyer sur le blocage de l'accélération et vérifier qu'il revient de lui-même en position initiale quand il est relâché.

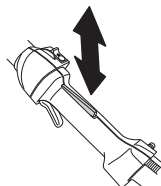

INSTRUCTIONS GÉNÉRALES DE SÉCURITÉ

Vérifier que le blocage de l'accélération, la commande d'accélération et leurs ressorts de rappel fonctionnent correctement.

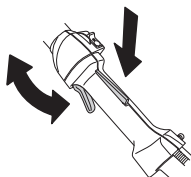

Voir le chapitre Démarrage. Démarrer la machine et donner les pleins gaz. Relâcher l'accélérateur et s'assurer que l'équipement de coupe s'arrête et qu'il reste immobile. Si l'équipement de coupe tourne lorsque l'accélérateur est au régime de ralenti, contrôler le réglage du ralenti du carburateur. Voir le chapitre Entretien.

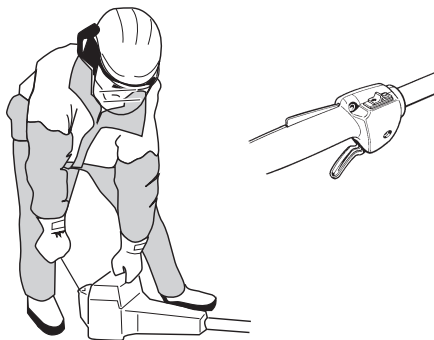

Bouton d'arrêt

Le bouton d'arrêt est utilisé pour arrêter le moteur.

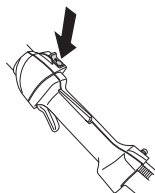

Mettre le moteur en marche et s'assurer qu'il s'arrête lorsque le bouton d'arrêt est amené en position d'arrêt.

Système anti-vibrations



La machine est équipée d'un système anti-vibrations conçu pour assurer une utilisation aussi confortable que possible.

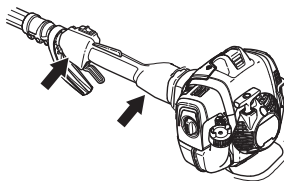

Le système anti-vibrations réduit la transmission des vibrations de l'unité moteur/l'équipement de coupe à l'unité que constituent les poignées.



AVERTISSEMENT! Une exposition excessive aux vibrations peut entraîner des troubles circulatoires ou nerveux chez les personnes sujettes à des troubles cardio-vasculaires. Consulter un médecin en cas de symptômes liés à une exposition excessive aux vibrations. De tels symptômes peuvent être: engourdissement, perte de sensibilité, chatouillements, picotements, douleur, faiblesse musculaire, décoloration ou modification épidermique. Ces symptômes affectent généralement les doigts, les mains ou les poignets. Les risques peuvent augmenter à basses températures.

Silencieux



Le silencieux est conçu pour réduire au maximum le niveau sonore et détourner les gaz d'échappement loin de l'utilisateur. Le silencieux équipé d'un pot catalytique est aussi conçu pour réduire la teneur des gaz d'échappement en substances toxiques.

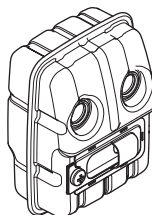

Le risque d'incendie est important dans les pays au climat chaud et sec. C'est pourquoi nous avons équipé certains

INSTRUCTIONS GÉNÉRALES DE SÉCURITÉ

silencieux de grilles antiflamme. Vérifier si le silencieux de la machine est muni d'un tel dispositif.



En ce qui concerne le silencieux, il importe de bien suivre les instructions de contrôle, de maintenance et d'entretien.

Ne jamais utiliser une machine dont le silencieux est défectueux.

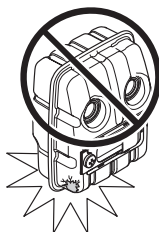

Vérifier régulièrement la fixation du silencieux dans la machine.

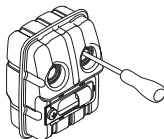

Si le silencieux comporte une grille antiflamme, la nettoyer régulièrement. Une grille colmatée résulte en un échauffement du moteur pouvant donner lieu à de graves avaries du moteur.

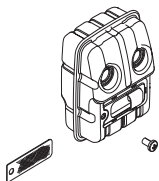

AVERTISSEMENT! Un silencieux muni d'un catalyseur est très chaud aussi bien à l'utilisation qu'après arrêt. Ceci est également vrai pour le régime au ralenti. Tout contact peut causer des brûlures à la peau. Attention au risque d'incendie!



AVERTISSEMENT! L'intérieur du silencieux contient des produits chimiques pouvant être cancérigènes. Éviter tout contact avec ces éléments si le silencieux est endommagé.



AVERTISSEMENT!

Les gaz d'échappement du moteur sont très chauds et peuvent contenir des étincelles pouvant provoquer un incendie. Par conséquent, ne jamais démarrer la machine dans un local clos ou à proximité de matériaux inflammables!

Équipement de coupe



Ce chapitre explique comment, grâce à un entretien correct et à l'utilisation d'un équipement de coupe adéquat, obtenir une capacité d'abattage maximale et une augmentation de la durée de vie de l'équipement de coupe.

- **N'utiliser que l'équipement de coupe recommandé!**

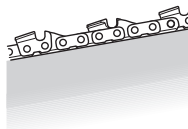

- **Veiller à ce que les dents de la chaîne soient toujours bien affûtées! Suivre les instructions et utiliser le gabarit d'affûtage recommandé.** Une chaîne émoussée ou endommagée augmente le risque d'accidents.



- **Veiller à travailler avec une profondeur de dent correcte! Suivre les instructions et utiliser la jauge de profondeur recommandée.** Une profondeur trop importante augmente le risque de rebond.

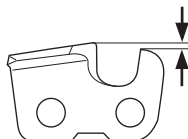

INSTRUCTIONS GÉNÉRALES DE SÉCURITÉ

- **Veiller à ce que la chaîne soit toujours bien tendue!** Une tension de chaîne insuffisante augmente le risque de rupture de chaîne ainsi que l'usure du guide, de la chaîne et du pignon.



- **Maintenir l'équipement de coupe bien lubrifié et bien entretenu!** Un équipement insuffisamment lubrifié augmente le risque de rupture de chaîne ainsi que l'usure du guide, de la chaîne et du pignon.



AVERTISSEMENT! Ne jamais utiliser une machine dont les équipements de sécurité sont défectueux. Contrôler et entretenir les équipements de sécurité de la machine conformément aux instructions données dans ce chapitre. Si les contrôles ne donnent pas de résultat positif, confier la machine à un atelier spécialisé.



AVERTISSEMENT! Toujours arrêter le moteur avant d'entamer des travaux sur l'équipement de coupe. Celui-ci continue de tourner après qu'on a relâché l'accélérateur. S'assurer que l'équipement de coupe est complètement immobilisé et débrancher le câble de la bougie d'allumage avant de commencer l'intervention sur l'équipement de coupe.

Caractéristiques du guide-chaîne et de la chaîne

Quand l'équipement de coupe livré avec la machine est usé ou endommagé et qu'un remplacement est nécessaire, utiliser uniquement les types de guide-chaîne et chaîne que nous recommandons.

Guide-chaîne

- Longueur (pouces/cm)

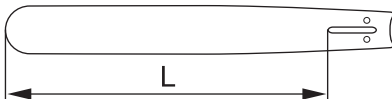

- Nombre de dents par pignon (T). Nombre réduit = petit rayon = tendance au rebond limitée.

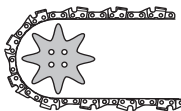

- Pas de chaîne (pouces). Le pignon du nez et le pignon d'entraînement doivent correspondre à l'espace entre les maillons.

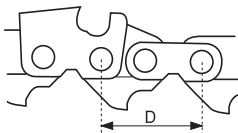

$$\text{PITCH} = \frac{D}{2}$$

- Nombre de maillons entraîneurs (pce). La longueur du guide, le pas de chaîne et le nombre de dents au pignon donnent un nombre déterminé de maillons entraîneurs.

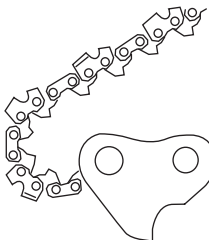

- Jauge du guide-chaîne (mm/pouces). Celle-ci doit correspondre à la jauge des maillons entraîneurs de la chaîne.

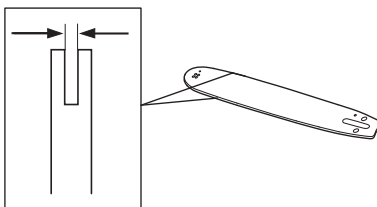

- Orifice de graissage et trou du goujon du tendeur de chaîne.

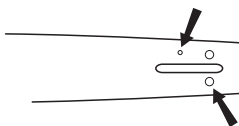

INSTRUCTIONS GÉNÉRALES DE SÉCURITÉ

Chaîne

- Pas de chaîne (pouce). (Distance entre trois maillons d'entraînement divisée par deux.)

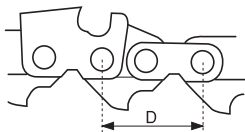

$$\text{PITCH} = \frac{D}{2}$$

- Jauge du maillon entraîneur (mm/pouces)

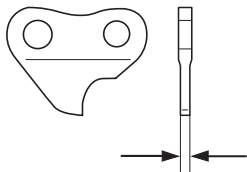

- Nombre de maillons entraîneurs (pce)

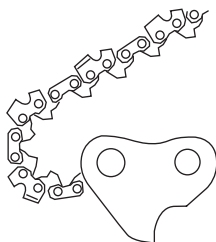

Affûtage et réglage de profondeur de la chaîne



AVERTISSEMENT! Une chaîne mal affûtée augmente le risque de rebond!

Généralités concernant l'affûtage des dents



- Ne jamais utiliser une tronçonneuse dont les dents sont émoussées. Une chaîne est émoussée quand les dents de la chaîne doivent être forcées contre le bois et les copeaux sont très petits. Une chaîne très usée ne produit pas de copeaux du tout. Le seul résultat est de la sciure.
- Une chaîne bien affûtée entame le bois par elle-même et sans forcer, laissant de gros et longs copeaux.
- La partie coupante de la chaîne consiste en un maillon coupant qui comporte une dent (A) et un

limiteur de profondeur (B). L'espace entre les deux détermine la profondeur de coupe.

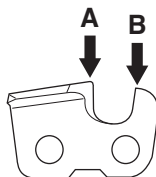

- Quatre dimensions doivent être prises en compte lors de l'affûtage d'une dent.

- Angle d'affûtage

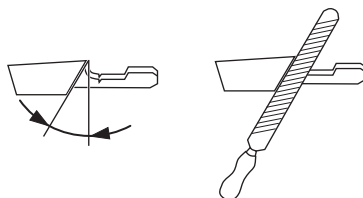

- Angle d'impact



- Position de la lime

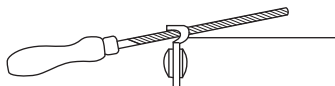

- Diamètre de la lime ronde

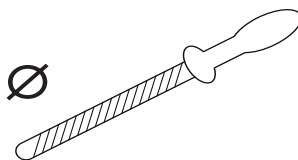

Affûter une chaîne sans outils spéciaux est très difficile. Il est donc recommandé d'utiliser notre gabarit. Il assure un

INSTRUCTIONS GÉNÉRALES DE SÉCURITÉ

affûtage de coupe maximal et une réduction optimale du risque de rebond.

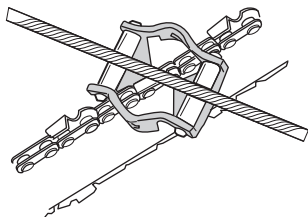

AVERTISSEMENT! La tendance au rebond augmente considérablement si les instructions d'affûtage ne sont pas respectées.

Affûtage de la dent



Cette opération nécessite une lime ronde et un gabarit.

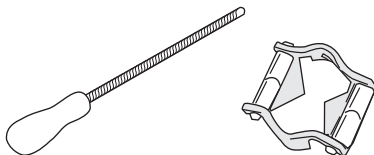

- S'assurer que la chaîne est tendue. Une tension insuffisante rend la chaîne instable latéralement, gênant ainsi l'affûtage de la chaîne.
- Toujours limer de l'intérieur de la dent vers l'extérieur. Soulager la lime sur le mouvement de retour. Commencer par limer toutes les dents du même côté du guide. Retourner le guide et limer les dents restantes de l'autre côté.

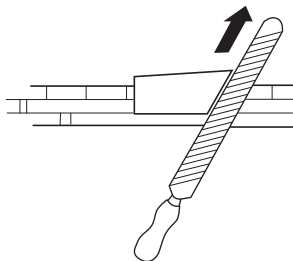

- Limer de manière à amener toutes les dents à la même hauteur. Si la hauteur de dent est inférieure à

4 mm (5/32"), la chaîne est usée et doit être remplacée.

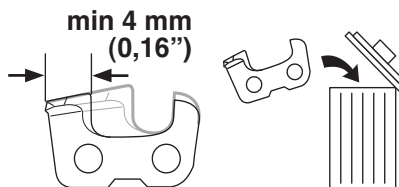

Généralités sur le réglage de la profondeur



- Quand la dent est affûtée, sa profondeur de coupe diminue. Pour conserver une capacité de coupe maximale, le limiteur de profondeur doit être placé sur le niveau recommandé.

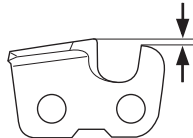

- Sur le modèle de maillon avec réduction de rebond, le bord avant du limiteur de profondeur est arrondi. Cette caractéristique doit être soigneusement conservée lors de l'affûtage.



- Nous recommandons l'utilisation de la jauge de profondeur qui permet à la fois un affûtage correct et préserve la forme arrondie du bord avant du limiteur de profondeur.

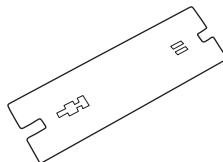

AVERTISSEMENT! Une profondeur excessive augmente le risque de rebond!

Réglage de la profondeur



- Le réglage de la profondeur doit être effectué sur des dents nouvellement affûtées.

INSTRUCTIONS GÉNÉRALES DE SÉCURITÉ

Un réglage de profondeur est recommandé tous les trois affûtages. REMARQUE! Cette recommandation suppose que la longueur des dents n'est pas anormalement réduite.

- Le réglage de la profondeur nécessite une lime plate et un gabarit de profondeur.

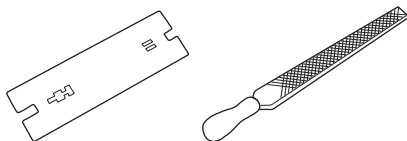

- Placer le gabarit sur le limiteur de profondeur.
- Placer la lime plate sur la partie dépassante du limiteur de profondeur et limer la partie superflue. Quand aucune résistance ne se fait sentir, le limiteur est à la hauteur correcte.

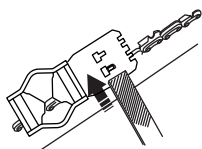

Tension de la chaîne



AVERTISSEMENT! Une tension insuffisante de la chaîne augmente le risque que la chaîne saute et donc de blessures graves, voire mortelles.

- Plus on utilise une chaîne, plus elle s'allonge. L'équipement de coupe doit être réglé après une telle altération.
- La tension de la chaîne doit être contrôlée après chaque plein d'essence. REMARQUE! Une nouvelle chaîne exige une période de rodage durant laquelle il faudra vérifier la tension plus souvent.
- En règle générale, il faut tendre la chaîne au maximum, mais pas au point de ne plus pouvoir la faire tourner manuellement.

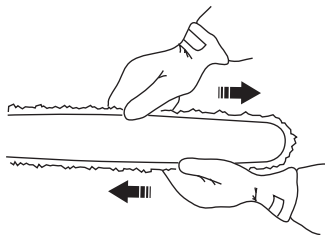

- Dévisser l'écrou du guide-chaîne.

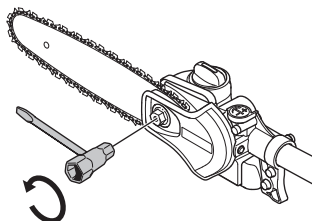

- Tendre la chaîne en tournant la vis du tendeur de chaîne vers la droite à l'aide de la clé universelle. Tendre la chaîne jusqu'à ce qu'elle ne pende plus sous le guide.

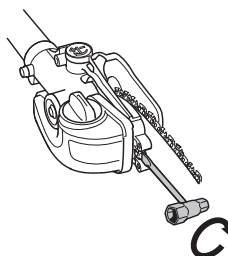

- Serrer l'écrou du guide à l'aide de la clé universelle. Contrôler que la chaîne peut tourner manuellement.

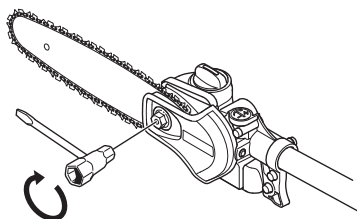

Lubrification de l'équipement de coupe



AVERTISSEMENT! Une lubrification insuffisante de l'équipement de coupe augmente le risque de rupture de chaîne et donc de blessures graves, voire mortelles.

Huile de chaîne de tronçonneuse

- L'huile de chaîne doit bien adhérer à la chaîne et posséder d'excellentes qualités de fluidité par tous les temps, aussi bien en été qu'en hiver.
- En tant que constructeur de tronçonneuses, nous avons développé une huile de chaîne optimale à base d'huile végétale. Nous recommandons l'utilisation de cette huile pour une durée de vie maximale de la chaîne et pour la protection de l'environnement.
- Si notre huile de chaîne n'est pas disponible, nous recommandons l'utilisation d'une huile de chaîne ordinaire.

INSTRUCTIONS GÉNÉRALES DE SÉCURITÉ

- Si aucune huile spécialement destinée à la lubrification des chaînes n'est disponible, on peut utiliser de l'huile de transmission EP 90.
- **Ne jamais utiliser de l'huile usagée!** C'est dangereux pour l'utilisateur, pour la machine et pour l'environnement.

Remplissage d'huile de chaîne



La pompe à huile est pré-réglée à l'usine pour répondre à la plupart des exigences de lubrification. En général, un plein de réservoir d'huile dure à peu près aussi longtemps qu'un plein de carburant. Contrôler donc la quantité d'huile dans le réservoir d'huile lors du plein de carburant afin d'éviter tout endommagement de la chaîne et du guide risquant de survenir en cas de lubrification insuffisante.

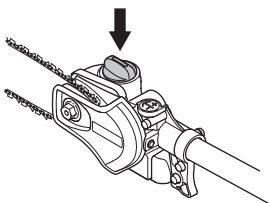

Contrôle de la lubrification de la chaîne

- Vérifier la lubrification à chaque plein d'essence. Diriger le nez du guide sur un objet fixe clair à une distance de 20 cm (8 pouces). Après 1 minute de marche à 3/4 de régime, l'objet clair doit nettement présenter un film d'huile en forme de ruban.

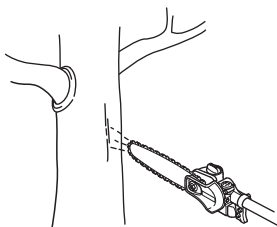

Réglage du graissage de la chaîne

Lors d'une découpe à sec ou d'une découpe de bois durs, il peut être nécessaire d'augmenter la lubrification. Tournez la vis de réglage dans le sens des aiguilles d'une montre pour augmenter le débit d'huile. N'oubliez pas que ceci va augmenter la consommation d'huile ; contrôlez régulièrement le niveau d'huile dans le réservoir. Tournez

la vis de réglage dans le sens contraire des aiguilles d'une montre pour réduire le débit d'huile.

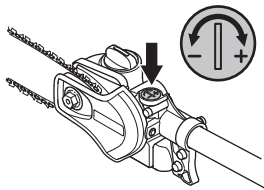

Mesures à prendre si le graissage ne fonctionne pas :



- Vérifier que les arrivées d'huile du guide ne soient pas obstruées. Nettoyer si nécessaire.

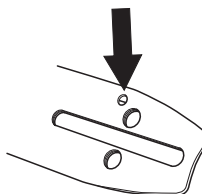

- S'assurer que le canal de graissage du carter d'engrenage est propre. Nettoyer si nécessaire.
- Vérifier que le pignon d'extrémité du guide tourne librement. Si le graissage de la chaîne ne fonctionne pas après les contrôles ci-dessus, s'adresser à un atelier de réparation.

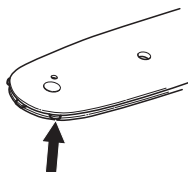

Contrôle de l'usure de l'équipement de coupe

Chaîne



Vérifier quotidiennement l'état de la chaîne et s'assurer :

- Que les rivets et les maillons ne comportent pas de fissures.
- Que la chaîne n'est pas raide.

INSTRUCTIONS GÉNÉRALES DE SÉCURITÉ

- Que les rivets et les maillons ne sont pas anormalement usés.

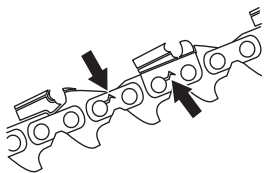

Il est recommandé de comparer avec une chaîne neuve pour évaluer le degré d'usure.

Si la hauteur de dent est inférieure à 4 mm (5/32 pouce), la chaîne est usée et doit être remplacée.

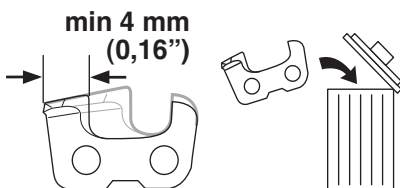

Pignon d'entraînement



Vérifier régulièrement le degré d'usure du pignon. Le remplacer en cas d'usure excessive.

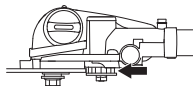

Guide-chaîne



Vérifier régulièrement:

- Qu'il n'y a pas de bavures sur les côtés extérieurs de la gorge. Les limer au besoin.

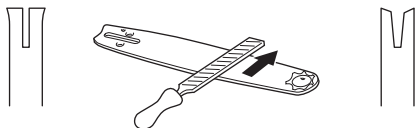

- Que la gorge du guide n'est pas anormalement usée. Remplacer le guide si nécessaire.
- Que le nez n'est pas anormalement ou irrégulièrement usé. Si un creux s'est formé à

l'extrémité du rayon du nez (bord inférieur), la chaîne n'était pas suffisamment tendue.

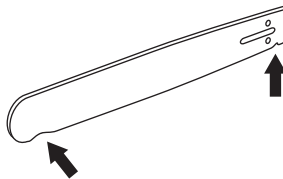

- Retourner le guide quotidiennement pour assurer une durée de vie optimale.

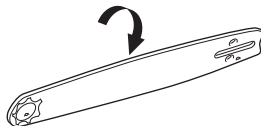

AVERTISSEMENT! Un équipement de coupe inadéquat peut augmenter les risques d'accidents.

MONTAGE

Montage de la tête de coupe



- Monter la tête de coupe sur le tube de transmission de manière à positionner la vis (A) au centre du trou du tube de transmission comme indiqué sur la figure.

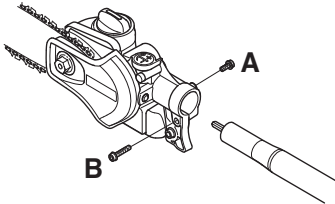

- Serrer la vis A.
- Serrer la vis B.

REMARQUE! S'assurer que l'arbre d'entraînement du tube de transmission pénètre dans la rainure de la tête de coupe.

Montage du guide-chaîne et de la chaîne



Retirer l'écrou du guide-chaîne et déposer le capot de protection.

Monter le guide-chaîne sur le boulon du guide. Placer le guide sur sa position la plus reculée. Placer la chaîne sur le pignon d'entraînement et dans la rainure du guide-chaîne. Commencer par le dessus du guide-chaîne.

S'assurer que la face tranchante des dents est vers l'avant sur le dessus du guide.

Monter le capot et localiser le goujon de tension de la chaîne (A) dans la rainure du guide. Contrôler que les maillons d'entraînement de la chaîne s'engagent dans le pignon (B) et que la chaîne est correctement placée dans la rainure du guide. Serrer l'écrou du guide à la main.

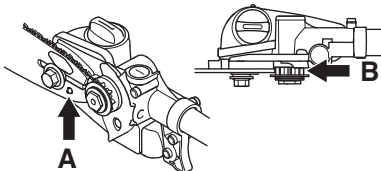

Tendre la chaîne en vissant la vis du tendeur de chaîne dans le sens des aiguilles d'une montre. Utiliser une clé

universelle ou visser à la main. Tendre la chaîne jusqu'à ce qu'elle ne pende plus sous le guide.

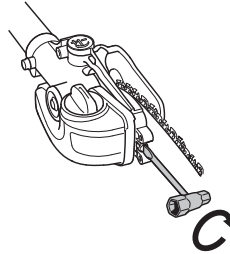

- La chaîne est tendue correctement quand elle ne pend pas sous le guide et peut toujours être avancée à la main sans difficulté. Serrer l'écrou du guide-chaîne avec la clé universelle tout en maintenant relevé le nez du guide.

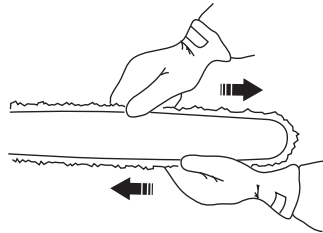

- La tension d'une chaîne neuve doit être vérifiée fréquemment pendant son rodage. Vérifier régulièrement la tension. Une tension correcte est synonyme de bonne capacité de coupe et de longue durée de vie.

Montage de la protection antichocs

Si la machine est équipée d'une plaque de protection antichocs sous le moteur, la retirer avant de mettre en place la protection antichocs.

Installer la protection à l'aide des trois vis. Serrer les vis au couple de 30 pi-lb. 4 N.m Resserrer les vis au couple de 4 N.m toutes les 20 heures d'utilisation.

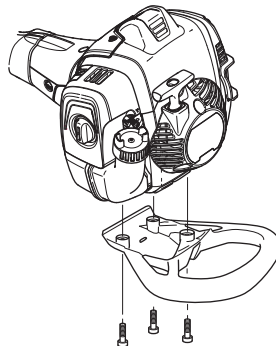

MONTAGE

Fonction télescopique



L'arbre de la machine est télescopique. Pour modifier la longueur de l'arbre, procédez comme suit :

- Desserrer la manette.

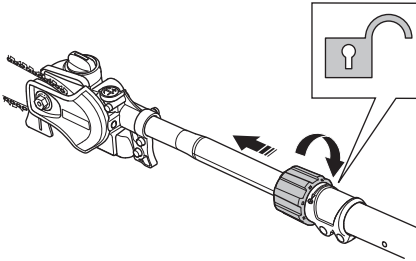

- Tirez sur l'arbre de façon à obtenir la longueur désirée.
- Resserrer la manette.

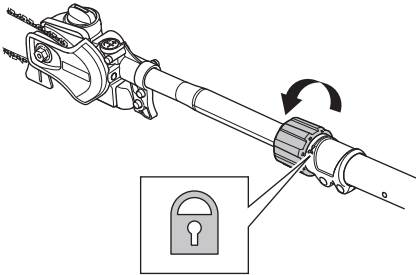

Réglage du harnais

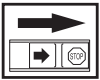

Le harnais doit toujours être utilisé avec la machine pour garantir à l'utilisateur un contrôle maximal sur la machine et réduire le risque de fatigue au niveau des bras et du dos.

- Enfiler le harnais.
- Accrochez le faisceau à un des crochets de la machine.

- Régler la longueur du harnais de telle sorte que le crochet de suspension soit à peu près à la hauteur de la hanche droite de l'utilisateur.



MANIPULATION DU CARBURANT

Sécurité carburant

Ne jamais démarrer la machine:

- 1 Si du carburant a été renversé. Essuyer soigneusement toute trace et laisser les restes d'essence s'évaporer.
- 2 Si vous avez renversé du carburant sur vous ou sur vos vêtements, changez de vêtements. Lavez les parties du corps qui ont été en contact avec le carburant. Utilisez de l'eau et du savon.
- 3 S'il y a fuite de carburant. Vérifier régulièrement que le bouchon du réservoir et la conduite de carburant ne fuient pas. En cas de fuite, communiquez avec un atelier spécialisé.

Transport et rangement

- Transporter et ranger la machine et le carburant de façon à éviter que toute fuite ou émanation éventuelle entre en contact avec une flamme vive ou une étincelle: machine électrique, moteur électrique, contact/interrupteur électrique ou chaudière.
- Lors du stockage et du transport de carburant, toujours utiliser un récipient homologué et conçu à cet effet.
- Lors des remisages de la machine, vider le réservoir de carburant. S'informer auprès d'une station-service comment se débarrasser du carburant résiduel. Vidangez le réservoir dans un contenant approprié et dans un endroit bien aéré.
- Avant de remettre la machine pour une période prolongée, veiller à ce qu'elle soit bien nettoyée et que toutes les mesures d'entretien aient été effectuées.
- Lors du stockage et du transport de la machine, toujours utiliser la protection de transport de l'équipement de coupe.
- Sécurisez la machine pendant le transport.
- Afin d'éviter tout démarrage accidentel du moteur, toujours retirer le chapeau de bougie lors du remisage prolongé, si la machine n'est pas sous surveillance et lors de toute mesure de service.
- Laisser la machine refroidir avant de la ranger dans la remise.



AVERTISSEMENT! Manipuler le carburant avec précaution. Penser aux risques d'incendie, d'explosion et d'inhalation.

Carburant

REMARQUE! La machine est équipée d'un moteur deux temps et doit toujours être alimentée avec un mélange d'essence et d'huile deux temps. Afin d'obtenir un mélange approprié, il est important de mesurer avec précision la quantité d'huile à mélanger. Pour le mélange de petites quantités de carburant, la moindre erreur peut sérieusement affecter le rapport du mélange.



AVERTISSEMENT! Le carburant et les vapeurs de carburant sont très inflammables et peuvent causer des blessures graves en cas d'inhalation ou de contact avec la peau. Il convient donc d'observer la plus grande prudence lors de la manipulation du carburant et de veiller à disposer d'une bonne aération.



AVERTISSEMENT! Veiller à une bonne aération pendant toute manipulation de carburant.

Essence



REMARQUE! Utilisez toujours un mélange essence/huile d'indice d'octane égal à au moins 90 (RON). Si la machine est équipée d'un pot catalytique (voir Caractéristiques techniques), utilisez toujours un mélange essence sans plomb/huile de bonne qualité. Une essence au plomb détruirait le pot catalytique.

Choisissez de l'essence écologique (alkylat) si vous pouvez vous en procurer.



Possibilité d'utiliser du carburant mélangé à base d'éthanol, E10 (la teneur en éthanol ne doit pas dépasser 10 %). L'utilisation de carburants mélangés contenant plus d'éthanol que l'E10 perturbe le fonctionnement de la machine et risque d'endommager le moteur.

Ce moteur est homologué pour fonctionner avec de l'essence sans plomb.

- L'indice d'octane le plus bas recommandé est de 87 ((RON+MON)/2). Si le moteur utilise une essence d'un indice d'octane inférieur à 87, des cognements risquent de se produire. Ceci résulte en une augmentation de la température du moteur et une charge élevée au niveau des paliers pouvant causer de graves avaries moteur.
- Si on travaille en permanence à des régimes élevés, il est conseillé d'utiliser un carburant d'un indice d'octane supérieur.

Huile deux temps

- Pour obtenir un fonctionnement et des résultats optimaux, utiliser une huile moteur deux temps HUSQVARNA fabriquée spécialement pour nos moteurs deux temps à refroidissement à air.
- Ne jamais utiliser d'huile deux temps pour moteurs hors-bord refroidis par eau, appelée huile outboard (désignation TCW).
- Ne jamais utiliser d'huile pour moteurs à quatre temps.

MANIPULATION DU CARBURANT

- Une huile de mauvaise qualité ou un rapport huile/carburant trop élevé pourrait affecter le fonctionnement du pot catalytique et en réduire la durée de vie utile.
- Rapport de mélange
50:1 (2%) avec huile deux temps HUSQVARNA.

Essence, litres	Huile deux temps, litres
	2% (1:50)
5	0,10
10	0,20
15	0,30
20	0,40
US gallon	US fl. oz.
1	2 1/2
2 1/2	6 1/2
5	12 7/8

Mélange

- Toujours effectuer le mélange dans un récipient propre et destiné à contenir de l'essence.
- Toujours commencer par verser la moitié de l'essence à mélanger. Verser ensuite la totalité de l'huile. Mélanger en secouant le récipient. Enfin, verser le reste de l'essence.
- Mélanger (secouer) soigneusement le mélange avant de faire le plein du réservoir de la machine.



- Ne jamais préparer plus d'un mois de consommation de carburant à l'avance.
- Si la machine n'est pas utilisée pendant une longue période, vidanger et nettoyer le réservoir.

Ce moteur est homologué pour fonctionner avec de l'essence sans plomb.



AVERTISSEMENT! Le pot d'échappement à catalyseur est très chaud pendant et après le service. C'est également vrai pour le ralenti. Soyez attentif au risque d'incendie, surtout à proximité de produits inflammables et/ou en présence de gaz.

Remplissage de carburant



AVERTISSEMENT! Les mesures de sécurité ci-dessous réduisent le risque d'incendie:

Mélangez et versez le carburant à l'extérieur, en l'absence d'étincelles ou de flammes.

Ne jamais fumer ni placer d'objet chaud à proximité du carburant.

Ne jamais faire le plein, moteur en marche.

Arrêter le moteur et le laisser refroidir pendant quelques minutes avant de faire le plein. Procédez au remplissage dans un endroit bien aéré. Ne remplissez jamais la machine à l'intérieur.

Ouvrir le bouchon du réservoir lentement pour laisser baisser la surpression pouvant régner dans le réservoir.

Serrer soigneusement le bouchon du réservoir après le remplissage.

Éloignez toujours la machine de la zone et de la source du plein en carburant avant de la mettre en marche.

- Utiliser un bidon d'essence comportant un dispositif d'arrêt de remplissage automatique.
- Si du carburant a été renversé. Essuyer soigneusement toute trace et laisser les restes d'essence s'évaporer.
- Nettoyer le pourtour du bouchon de réservoir. Les impuretés dans le réservoir causent des troubles de fonctionnement.
- Bien mélanger le carburant en agitant le récipient avant de remplir le réservoir.

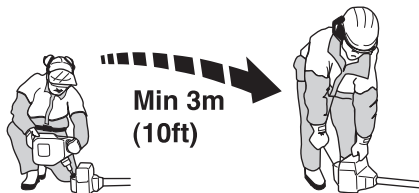

DÉMARRAGE ET ARRÊT

Contrôles avant la mise en marche



- Inspecter la zone de travail. Retirer tout objet susceptible d'être projeté.
- Vérifier l'équipement de coupe. Ne jamais utiliser un équipement émoussé, fissuré ou endommagé.
- Vérifier que la machine est en parfait état d'utilisation. Contrôler que tous les écrous et boulons sont correctement serrés.
- S'assurer que la chaîne est suffisamment lubrifiée.
- Contrôler que l'équipement de coupe s'arrête toujours au ralenti.
- Utiliser la machine uniquement pour les travaux auxquels elle est destinée.
- Contrôler que la poignée et les dispositifs de sécurité sont en bon état. Ne jamais utiliser une machine dont une pièce est manquante ou ayant été modifiée contrairement aux spécifications.

Remplissage d'huile



- Ouvrir le couvercle sur la partie supérieure de la tête de coupe.

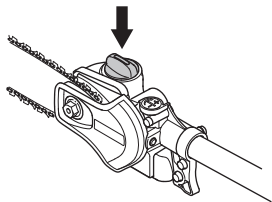

- Faire l'appoint avec de l'huile de chaîne Husqvarna.
- Refermer le couvercle.

Démarrage et arrêt



AVERTISSEMENT! Un carter d'embrayage complet avec tube de transmission doit être monté avant de démarrer la machine, sinon l'embrayage risque de lâcher et de provoquer des blessures.

Éloignez toujours la machine de la zone et de la source du plein en carburant avant de la mettre en marche. Placer la machine sur une surface plane. S'assurer que l'équipement de coupe ne risque pas de rencontrer un obstacle. Veiller à ce qu'aucune personne non autorisée ne se trouve dans la zone de travail pour éviter le risque de blessures graves. Distance de sécurité: 15 mètres (50 ft.).

Démarrage



Pompe à carburant: Appuyer sur la poche en caoutchouc de la pompe à carburant plusieurs fois jusqu'à ce que le carburant commence à remplir la poche. Il n'est pas nécessaire de remplir la poche complètement.

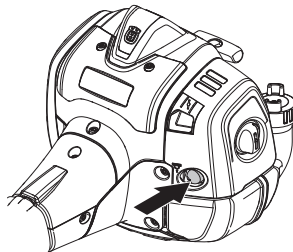

DÉMARRAGE ET ARRÊT

Starter: Tirer la commande de starter.

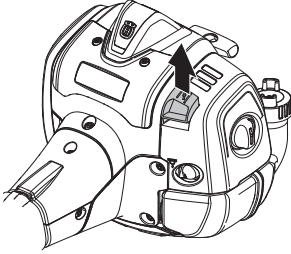

AVERTISSEMENT! Lorsque le moteur est démarré avec la commande de starter en position starter, l'équipement de coupe commence à tourner immédiatement.

Plaquer la machine contre le sol à l'aide de la main gauche (NOTA! Pas à l'aide du pied!). Saisir ensuite la poignée de démarrage de la main droite et tirer lentement sur le lanceur jusqu'à ce qu'une résistance se fasse sentir (les cliquets d'entraînement grippent), puis tirer énergiquement et rapidement sur le lanceur. **Ne jamais enrouler la corde du lanceur autour de la main.**

Tirez plusieurs fois sur le fil jusqu'à ce que le moteur tente de démarrer (ou 5 fois au maximum).

Déplacez la commande du volet de départ à la position du volet de marche.

Tirez sur le fil jusqu'à ce que le moteur démarre, puis actionnez progressivement la gâchette d'accélération pour augmenter le régime du moteur jusqu'à atteindre la vitesse de fonctionnement. La gâchette se désengagera automatiquement des paramètres de démarrage.

REMARQUE! Ne pas sortir complètement la corde du lanceur et ne pas lâcher la poignée avec la corde du lanceur complètement sortie. Cela pourrait endommager la machine.



REMARQUE! Ne pas placer aucune partie du corps sur la surface marquée. Contact peut causer en brûlures à la peau ou les chocs électriques si le chapeau de bougie est

défectueux. Toujours utiliser des gants. Ne jamais utiliser une machine dont le chapeau de bougie est défectueux.

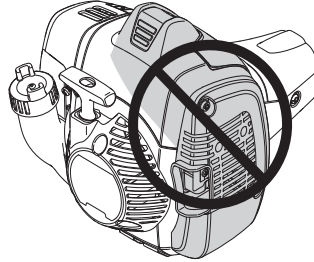

Arrêt

Pour arrêter le moteur, couper l'allumage.

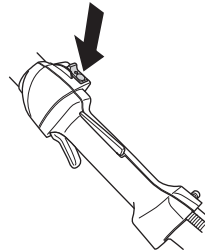

REMARQUE! L'interrupteur d'arrêt se remet automatiquement en position de démarrage. Toujours retirer le chapeau de bougie de la bougie lors du montage, contrôle et/ou entretien, afin d'éviter tout démarrage accidentel.

TECHNIQUES DE TRAVAIL

Méthodes de travail

IMPORTANT!

Ce chapitre traite des consignes de sécurité de base lors du travail avec une tronçonneuse à perche.

Dans l'éventualité d'une situation rendant la suite du travail incertaine, consulter un expert. S'adresser au revendeur ou à l'atelier de réparation.

Évitez les tâches pour lesquelles vous ne vous sentez pas suffisamment qualifié.



AVERTISSEMENT! La machine peut provoquer des blessures personnelles graves. Lire attentivement les consignes de sécurité. Apprendre à bien utiliser la machine.



AVERTISSEMENT! Outil coupant. Ne pas toucher l'outil sans avoir préalablement coupé le moteur.

Protection personnelle



- Toujours porter des bottes ainsi que l'équipement de protection indiqué au chapitre Equipement de protection personnelle.
- Toujours porter des vêtements de travail et des pantalons longs résistants.
- Ne jamais porter des vêtements amples ou des bijoux.
- Éviter les cheveux longs en dessous des épaules.

Consignes de sécurité pour l'entourage

- Ne jamais laisser un enfant utiliser la machine.
- S'assurer qu'aucune personne ne s'approche à moins de 15 m pendant le travail.
- Ne jamais laisser d'autres personnes utiliser la machine sans s'être assuré au préalable que ces personnes ont bien compris le contenu du mode d'emploi.

- Ne jamais travailler debout sur une échelle, un tabouret, ou dans toute autre position élevée n'offrant pas une sécurité maximale.



Consignes de sécurité pendant le travail



- Toujours adopter une position de travail sûre et stable.
- Toujours tenir la machine avec les deux mains. Porter la machine sur le côté du corps.



- Utiliser la main droite pour manœuvrer l'accélération.
- Veiller à ce que ni les mains ni les pieds ne soient en contact avec l'équipement de coupe quand le moteur tourne.
- Après l'arrêt du moteur, maintenir mains et pieds à l'écart de l'équipement de coupe jusqu'à l'arrêt total de celui-ci.
- Toujours poser la machine sur le sol quand elle n'est pas utilisée.
- Attention aux éclats de bois pouvant être projetés durant le sciage.
- Vous devez tenir compte du fait que les branches qui tombent peuvent rebondir en direction de l'utilisateur après avoir heurté le sol.
- Inspecter la zone de travail pour s'assurer qu'il n'y a aucun objet étranger tel que des câbles électriques, aucun insecte ni animal, etc., ni aucun objet pouvant

TECHNIQUES DE TRAVAIL

endommager l'équipement de coupe, tel que des objets métalliques.

- Utiliser le harnais pour faciliter la manipulation de la machine et en alléger le poids.



- Arrêter immédiatement la machine si elle bute sur un objet ou si des vibrations se produisent. Débrancher le câble de la bougie. Vérifier que la machine n'a subi aucun dommage. Réparer tout éventuel dommage.
- Si quelque chose se coince dans l'équipement de coupe pendant le travail, arrêter le moteur, le laisser s'arrêter complètement et débrancher le câble d'allumage avant de nettoyer l'équipement de coupe.
- Cette machine ne comporte pas d'isolation électrique. Si la machine entre en contact avec ou est utilisée à proximité de lignes conductrices de tension, ceci peut résulter en des blessures personnelles graves voire mortelles.

Consignes de sécurité après le travail



- La protection pour le transport doit toujours être mise sur l'équipement de coupe quand la machine n'est pas utilisée.
- Avant de commencer les travaux de nettoyage, de réparation ou d'inspection, s'assurer que l'équipement de coupe est arrêté. Débrancher le câble d'allumage de la bougie.
- Toujours utiliser des gants de protection robustes lors de la réparation de l'équipement de coupe. Il est très tranchant et peut facilement provoquer des coupures.

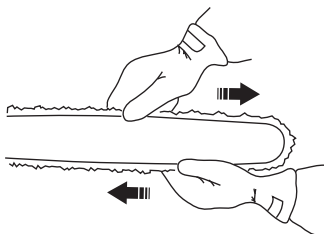

- Ranger la machine hors de portée des enfants.
- Utiliser uniquement des pièces de rechange d'origine pour réparer la machine.

Techniques de travail de base

- Pour un meilleur équilibre, tenir la machine le plus près possible du corps.



- S'assurer que l'extrémité ne touche pas le sol.
- Ne jamais forcer, mais adopter un rythme de travail régulier, de sorte que toutes les branches puissent être coupées uniformément.
- Ramener le moteur au régime de ralenti après chaque étape de travail. Laisser le moteur tourner à pleins gaz sans lui faire subir de charge peut endommager sérieusement le moteur.
- Toujours travailler en faisant tourner le moteur à plein régime.
- Mettre le moteur au ralenti après chaque coupe. Le fonctionnement du moteur à plein régime sur des périodes prolongées peut endommager l'embrayage centrifuge.



AVERTISSEMENT! Ne jamais se tenir sous une branche en train d'être coupée. Une telle position peut être la cause de blessures graves voire mortelles.

Observer la plus grande prudence en cas de travail à proximité de lignes électriques. Les branches peuvent entraîner des court-circuits en tombant.



AVERTISSEMENT! Observer les consignes de sécurité en vigueur en cas de travail à proximité de lignes électriques.

TECHNIQUES DE TRAVAIL



AVERTISSEMENT! Cette machine ne comporte pas d'isolation électrique. Si la machine entre en contact avec ou est utilisée à proximité de lignes conductrices de tension, ceci peut résulter en des blessures personnelles graves voire mortelles. L'électricité peut être transmise d'un point à un autre par un arc de tension. Plus la tension est élevée et plus la longueur de transmission de la tension est élevée. L'électricité peut également être transmise par des branches et d'autres objets, particulièrement s'ils sont mouillés. Toujours conserver une distance d'au moins 10 mètres entre la machine et la ligne conductrice d'électricité et/ou les objets en contact avec cette ligne. S'il est nécessaire que le travail soit effectué avec des distances de sécurité plus courtes, toujours contacter la compagnie électrique afin de s'assurer que la tension a bien été coupée avant de commencer les travaux.



AVERTISSEMENT! La machine a une longue portée. Vérifier qu'aucune personne et qu'aucun animal ne se trouvent à moins de 15 mètres quand la machine est utilisée. Ne tournez jamais sur vous-même avec la machine sans vous assurer d'abord que personne ne se trouve dans la zone de sécurité.

- Trouver la bonne position par rapport à la branche de sorte que la coupe se fasse, si possible, à un angle de 90° par rapport à la branche.

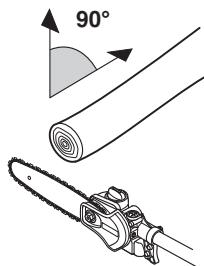

- Ne pas travailler avec le manche droit devant le corps (comme avec une canne à pêche) car, dans une telle position, l'équipement de coupe semble plus lourd.
- Couper les grosses branches par sections afin que leur emplacement de chute soit plus facile à contrôler.

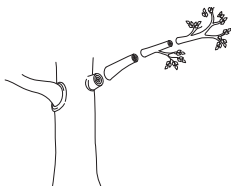

- Ne jamais scier dans un nœud dans la mesure où ceci favorise la cicatrisation et ralentit la décomposition!

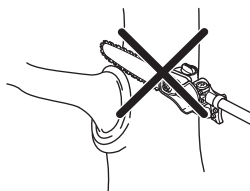

- Réaliser une entaille de décharge sur la partie inférieure de la branche avant de couper cette dernière. Cette entaille empêche l'écaillage de l'écorce de l'arbre pouvant provoquer des blessures durables et difficiles à guérir sur l'arbre. Pour éviter tout blocage, la profondeur de cette entaille ne doit pas dépasser 1/3 de l'épaisseur de la branche. Toujours retirer l'équipement de coupe de la branche avec la chaîne qui tourne afin d'éviter le blocage de l'équipement de coupe.

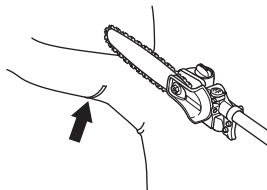

- Utiliser le harnais pour faciliter la manipulation de la machine et en alléger le poids.



- Veiller à se tenir fermement et à pouvoir travailler sans être gêné par les branches, les pierres et les arbres.



AVERTISSEMENT! Ne jamais accélérer si l'équipement de coupe n'est pas entièrement visible.

Carburateur

Réglage du régime de ralenti

Pour tous les réglages, le filtre à air doit être propre et son couvercle posé.

Régler le régime de ralenti avec le pointeau de ralenti T si un ajustage est nécessaire. Tourner d'abord le pointeau T dans le sens des aiguilles jusqu'à ce que l'équipement de coupe commence à tourner. Tourner ensuite le pointeau dans le sens inverse jusqu'à l'arrêt de l'équipement de coupe. Un régime de ralenti correctement réglé permet au moteur de tourner régulièrement dans toutes les positions. Il doit également y avoir une bonne marge avant que l'équipement de coupe se mette à tourner.

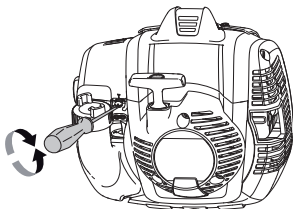

Régime de ralenti recommandé: Voir le chapitre Caractéristiques techniques.



AVERTISSEMENT! S'il est impossible de régler le régime de ralenti de manière à immobiliser l'équipement de coupe, contacter le revendeur ou l'atelier de réparation. Ne pas utiliser la machine tant qu'elle n'est pas correctement réglée ou réparée.

Silencieux



REMARQUE! Certains silencieux sont dotés d'un pot catalytique. Voir le chapitre Caractéristiques techniques pour déterminer si la machine est pourvue d'un pot catalytique.

Le silencieux est conçu pour atténuer le bruit et dévier le flux des gaz d'échappement loin de l'utilisateur. Ces gaz sont chauds et peuvent transporter des étincelles

risquant de causer un incendie si elles entrent en contact avec un matériau sec et inflammable.

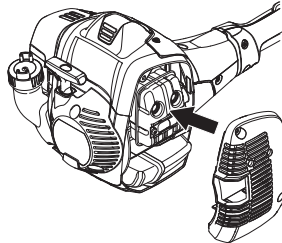

Certains silencieux sont munis d'une grille antiflamme. Cette grille doit être nettoyée une fois par semaine si la machine en est équipée. Utiliser de préférence une brosse en acier.



Sur les silencieux sans pot catalytique, la grille doit être nettoyée et si nécessaire remplacée une fois par semaine. Sur les machines dont le silencieux est muni d'un pot catalytique, la grille devra être inspectée et si nécessaire nettoyée une fois par mois. **Si la grille est abîmée, elle devra être remplacée.**

Si la grille est souvent bouchée, ceci peut être dû à un mauvais fonctionnement du pot catalytique. Contacter le revendeur pour effectuer un contrôle. Une grille antiflamme bouchée provoque la surchauffe de la machine et la détérioration du cylindre et du piston. Voir également les indications au chapitre Entretien.

REMARQUE! Ne jamais utiliser la machine si le silencieux est en mauvais état.



AVERTISSEMENT! Un silencieux muni d'un catalyseur est très chaud aussi bien à l'utilisation qu'après arrêt. Ceci est également vrai pour le régime au ralenti. **Tout contact peut causer des brûlures à la peau. Attention au risque d'incendie!**

Système de refroidissement



La machine est équipée d'un système de refroidissement permettant d'obtenir une température de fonctionnement aussi basse que possible.

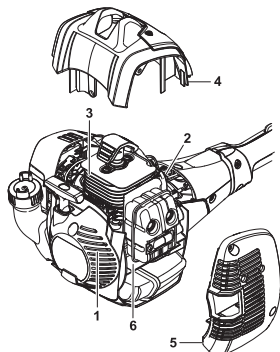

Le système de refroidissement est composé des éléments suivants:

- 1 La prise d'air dans le lanceur.
- 2 Les ailettes de ventilation sur le volant.
- 3 Les ailettes de refroidissement sur le cylindre.
- 4 Le carter de cylindre (dirige l'air de refroidissement vers le cylindre).

Nettoyer le système de refroidissement avec une brosse une fois par semaine, voire plus souvent dans des conditions difficiles. Un système de refroidissement sale ou colmaté provoque la surchauffe de la machine, endommageant le cylindre et le piston.

Bougie



L'état de la bougie dépend de:

- L'exactitude du réglage du carburateur.
- Mauvais mélange de l'huile dans le carburant (trop d'huile ou huile inappropriée).
- La propreté du filtre à air.

Ces facteurs peuvent concourir à l'apparition de calamine sur les électrodes, ce qui à son tour entraîne un mauvais fonctionnement du moteur et des démarrages difficiles.

Si la puissance de la machine est trop faible, si la machine est difficile à mettre en marche ou si le ralenti est irrégulier, toujours commencer par contrôler l'état de la bougie avant de prendre d'autres mesures. Si la bougie est encrassée, la nettoyer et vérifier que l'écartement des

électrodes est de 0,65 mm. Remplacer la bougie une fois par mois ou plus souvent si nécessaire.

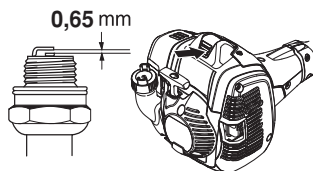

REMARQUE! Toujours utiliser le type de bougie recommandé! Une bougie incorrecte peut endommager le piston/le cylindre. S'assurer que la bougie est dotée d'un antiparasites.

Filtre à air

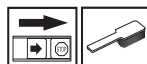

Le filtre à air doit être maintenu propre pour éviter:

- Un mauvais fonctionnement du carburateur.
- Des problèmes de démarrage.
- Une perte de puissance.
- Une usure prématurée des éléments du moteur
- Une consommation anormalement élevée de carburant

Nettoyer le filtre après 25 heures de service, ou plus souvent si les conditions de travail sont exceptionnellement poussiéreuses.

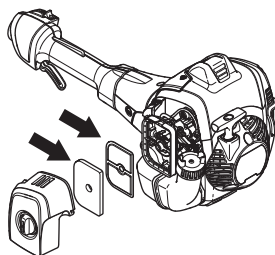

Nettoyage du filtre à air

Fermez la soupape du starter en déplaçant la soupape vers le haut.

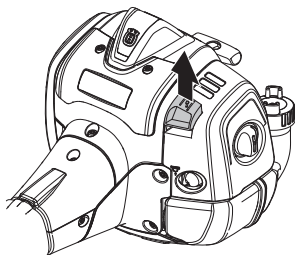

Déposer le capot de filtre et retirer le filtre. Nettoyer à l'air comprimé.

IMPORTANT! N'utiliser que les pièces de rechange HUSQVARNA. L'utilisation de pièces d'autres marques pourrait endommager votre machine ou encore causer des blessures à l'opérateur ou à d'autres personnes. Votre garantie ne couvre ni les dommages ni la responsabilité causés par l'utilisation d'accessoires et/ou de pièces qui ne sont pas spécialement recommandés par HUSQVARNA.

Engrenage

IMPORTANT!

Toutes les opérations de service sur la tête de scie doivent être effectuées par un revendeur Husqvarna agréé.

Utilisez toujours de la graisse Husqvarna d'origine pour éviter d'endommager l'entraînement dans la tête de scie.

Utilisez de la graisse portant la référence: 579 06 49-01

ENTRETIEN

Schéma d'entretien

La liste ci-dessous indique l'entretien à effectuer sur la machine. La plupart des points sont décrits à la section Entretien. L'utilisateur ne peut effectuer que les travaux d'entretien et de révision décrits dans ce manuel d'utilisation. Les mesures plus importantes doivent être effectuées dans un atelier d'entretien agréé.

Entretien	Entretien Quotidien	Entretien hebdomadaire	Entretien mensuel
Nettoyer l'extérieur de la machine.	X		
Contrôler le bon fonctionnement du verrou d'accélérateur et de l'accélérateur	X		
Contrôler le bon fonctionnement du contacteur d'arrêt.	X		
S'assurer que l'équipement de coupe ne tourne pas lorsque le moteur tourne au ralenti.	X		
Nettoyer le filtre à air. Le remplacer si nécessaire.	X		
S'assurer que toutes les vis et tous les écrous sont bien serrés.	X		
Vérifier qu'il n'y a pas de fuite de carburant du moteur, du réservoir ou des conduits de carburant.	X		
Nettoyer sous le capot de protection.	X		
Vérifier que les rivets et les maillons de la chaîne sont dépourvus de fissures, que la chaîne n'est pas raide et que les rivets et les maillons ne sont pas anormalement usés.	X		
Contrôler le démarreur et son lanceur.		X	
S'assurer que les amortisseurs ne sont pas endommagés.		X	
Nettoyer la bougie d'allumage extérieurement. Déposer la bougie et vérifier la distance entre les électrodes. Au besoin, ajuster la distance de sorte qu'elle soit de 0,65 mm (.026"), ou remplacer la bougie. S'assurer que la bougie est dotée d'un antiparasites.		X	
Nettoyer le système de refroidissement de la machine.		X	
Nettoyer ou remplacer la grille antiflamme du silencieux (valable uniquement pour les silencieux sans pot catalytique).		X	
Nettoyer le carburateur extérieurement, ainsi que l'espace autour.		X	
Limer les bavures éventuelles sur les côtés du guide-chaîne.		X	
Nettoyer le réservoir de carburant.			X
Contrôler que le filtre à carburant n'est pas contaminé ou que le tuyau de carburant ne comporte pas de fissures ou d'autres avaries. Remplacer si nécessaire.			X
Inspecter tous les câbles et connexions.			X
Vérifier l'état d'usure de l'embrayage, des ressorts d'embrayage et du tambour d'embrayage. Faire remplacer si nécessaire dans un atelier d'entretien agréé.			X
Remplacer la bougie d'allumage. S'assurer que la bougie est dotée d'un antiparasites.			X
Contrôler et nettoyer la grille antiflamme du silencieux (valable uniquement pour les silencieux avec pot catalytique).			X

CARACTÉRISTIQUES TECHNIQUES

Caractéristiques techniques

525PT5S

Moteur

Cylindrée, po ³ /cm ³	1,55/25,4
Alésage, po/mm	1,34/34
Course, po/mm	1,10/28
Régime d'emballement maximal recommandé, tr/min	11000-12000
Régime de ralenti, tr/min	2800-3000
Puissance moteur maxi selon ISO 8893, kW/ tr/min	1.0/8500
Silencieux avec pot catalytique	Oui
Système d'allumage réglé en fonction du régime	Oui

Système d'allumage

Bougie	NGK BPMR8Y
Écartement des électrodes, po/mm	0.02/0,5

Système de graissage/de carburant

Contenance du réservoir de carburant, pint/litres	1,06/0,5
Contenance du réservoir d'huile, pint/litre	0,30/0,14

Poids

Poids sans carburant, sans huile et sans outil de coupe, kg	16/7,2
---	--------

Niveaux sonores

(voir rem. 1)

Pression acoustique équivalente au niveau des oreilles de l'utilisateur, mesurée selon ISO 22868, dB(A):	89
--	----

Niveaux de vibrations

(voir remarque 2)

Niveau de vibrations au niveau des poignées mesuré selon EN ISO 22867, m/s²







Manche court, poignée avant/arrière	6,3/5,3
Manche long, poignées avant/arrière	4,1/6,7

Remarque 1: Les données reportées pour le niveau de pression sonore équivalent pour la machine montrent une dispersion statistique typique (déviations standard) de 1 dB (A).

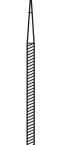
Remarque 2: Les données reportées pour le niveau de vibrations équivalent montrent une dispersion statistique typique (déviations standard) de 1 m/s².

Combinaisons guide-chaîne et chaîne

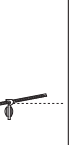
Guide-chaîne			Chaîne	
Longueur, pouces	Pas, pouces/mm	Jauge, pouces	Type	Longueur, maillons entraîneurs (pce)
12	3/8	0.050	H35	44

							
35	5/32 / 4.0	80°	30°	0°	0.025/0.65		5796536-01

IMPORTANT: Ce produit est conforme à la réglementation de la Phase 3 de l'Agence de Protection de l'Environnement des États-Unis (EPA) en ce qui touche les émissions d'échappement et d'évaporation. Pour assurer la conformité à la Phase 3 de l'EPA, nous recommandons le recours à des pièces de remplacement d'origine Husqvarna uniquement. L'utilisation de pièces de remplacement non conformes est une infraction à la législation fédérale.

VOS DROITS ET OBLIGATIONS EN GARANTIE

EPA (U.S. Environmental Protection Agency), CARB (California Air Resources Board), Environment Canada et Husqvarna Forest & Garden ont le plaisir d'expliquer la garantie relative au système de contrôle des émissions des petits moteurs fabriqués en 2015-2016*. Aux États-Unis et au Canada, les nouveaux équipements utilisant de petits moteurs doivent être conçus, fabriqués et équipés conformément aux normes d'anti-pollution atmosphérique applicables en Californie ou au niveau fédéral. Husqvarna Forest & Garden doit garantir les systèmes de contrôle antipollution de votre petit moteur hors route pendant la période figurant sur la liste ci-dessous à condition que votre petit moteur hors route ne présente aucun signe d'abus, de négligence ou d'entretien inapproprié. Votre système de contrôle antipollution peut comprendre des pièces telles qu'un carburateur, un système d'injection de carburant, un système d'allumage, un pot catalytique, des réservoirs de carburant, des canalisations d'essence, des bouchons de réservoir de carburant, des clapets, des absorbeurs, des filtres, des durites de vapeur, des pinces, des connecteurs et d'autres composants associés reliés aux émissions. Des tuyaux, courroies, connecteurs, capteurs et d'autres équipements relatifs à la protection contre les émissions sont inclus. Si la garantie est applicable, Husqvarna Forest & Garden s'engage à réparer votre petit moteur à ses frais, diagnostic, pièces et main d'oeuvre compris.

GARANTIE DU FABRICANT

Le système antipollution est garanti deux ans. Si une pièce de votre moteur liée aux émissions est défectueuse, elle doit alors être réparée ou remplacée par Husqvarna Forest & Garden.

CHARGES DE LA GARANTIE DE L'UTILISATEUR

- En tant que propriétaire d'un petit moteur, vous êtes responsable d'effectuer la maintenance décrite dans le manuel de l'utilisateur de la machine. Husqvarna Forest & Garden vous recommande de conserver toutes les factures prouvant que des mesures de maintenance ont été effectuées ; Cependant, Husqvarna Forest & Garden ne peut en aucun cas refuser une demande de prise en charge selon les

termes de la garantie si les factures ne peuvent pas être produites ou si toutes les mesures de maintenance prescrites n'ont pas été effectuées.

- En tant que propriétaire d'un petit moteur, vous devez néanmoins savoir que Husqvarna Forest & Garden peut refuser votre demande en garantie si la panne du moteur ou d'un de ses composants est due à une utilisation abusive, à des négligences, à une maintenance inappropriée ou des modifications non approuvées.
- Il vous incombe d'apporter votre moteur à un centre de distribution ou d'entretien Husqvarna Forest & Garden dès que le problème est détecté. Les réparations couvertes par la garantie doivent être effectuées dans des délais raisonnables inférieurs à 30 jours.

Pour toute question relative à la couverture de votre garantie, communiquez avec Husqvarna Forest & Garden au CANADA au 1-800-805-5523, ou aux ÉTATS-UNIS au 1-800-487-5951, ou envoyez un courriel à l'adresse emissions@husqvarnagroup.com.

DATE D'ENTRÉE EN VIGUEUR DE LA GARANTIE

La période de garantie commence à la date à laquelle le moteur ou l'équipement est livré à l'acheteur final.

DURÉE DE LA GARANTIE

Husqvarna Forest & Garden garantit à l'acheteur final et à tout propriétaire ultérieur que le moteur ou l'équipement est conçu, construit et équipé conformément à toutes les réglementations applicables adoptées par EPA et CARB et qu'il ne comporte pas de défauts de matériel ou de fabrication pouvant causer la panne d'une pièce sous garantie durant une période de deux (2) ans.

CE QUI EST COUVERT PAR LA GARANTIE

RÉPARATION OU REMPLACEMENT DE PIÈCES: La réparation ou le remplacement de toute pièce sous garantie, dans le cadre de la garantie, doit être effectué sans frais pour le propriétaire dans un atelier agréé. Les révisions ou réparations couvertes par la garantie seront disponibles dans tous les centres de distribution Husqvarna Forest & Garden agréés pour l'entretien de ce type de moteur. Durant la période de garantie de deux ans des systèmes de contrôle des émissions, Husqvarna Forest & Garden s'engage à maintenir un stock adéquat des pièces sous garantie afin de répondre à la demande pour ce type de pièces.

PÉRIODE DE GARANTIE: Toute pièce sous garantie devant être remplacée conformément au calendrier de maintenance est garantie pour la période de temps précédant le premier remplacement planifié pour cette pièce. Si la pièce tombe en panne avant le premier remplacement planifié, elle sera réparée ou remplacée gratuitement par Husqvarna Forest & Garden. Toute pièce réparée ou remplacée durant la période de garantie

DÉCLARATION DE GARANTIE CONTRÔLE DES ÉMISSIONS EN CALIFORNIE ET AU NIVEAU

est garantie pour le reste de la période précédant le premier remplacement planifié pour cette pièce. Toute pièce qui n'est pas supposée être remplacée comme requis dans le calendrier de maintenance est garantie deux (2) ans. Si la pièce tombe en panne durant la période de garantie, elle sera réparée ou remplacée gratuitement par Husqvarna Forest & Garden. Toute pièce réparée ou remplacée durant la période de garantie est garantie pour la période de garantie restante. Toute pièce couverte par la garantie et devant être inspectée régulièrement conformément au calendrier de maintenance, sera garantie pour une période de deux (2) ans. L'indication "réparer ou remplacer selon les besoins" dans les instructions ne limite pas la période de garantie. Toute pièce réparée ou remplacée durant la période de garantie est garantie pour la période de garantie restante.

DIAGNOSTIC: Les mesures de diagnostic permettant de déterminer le dysfonctionnement d'une pièce sous garantie ne sont pas à la charge du propriétaire à condition que ces mesures soient effectuées dans un atelier agréé selon la garantie.

DOMMAGES INDIRECTS: Husqvarna Forest & Garden est responsable des dommages aux autres composants du moteur causés par une panne de toute pièce sous garantie survenant durant la période de garantie.

LISTE DES PIÈCES GARANTIE ÉMISSIONS

- 1 Carburateur et pièces internes
- 2 Conduit d'entrée, porte-filtre du filtre à air et boulons du carburateur
- 3 Filtre à air et filtre à carburant garantis selon l'entretien prévu
- 4 Bougie garantie selon l'entretien prévu
- 5 Module d'allumage
- 6 Réservoir de carburant, conduite et bouchon

CE QUI N'EST PAS COUVERT PAR LA GARANTIE

Aucune défaillance résultant de l'abus, de la négligence et de l'entretien contraire aux instructions n'est couverte par la garantie.

AJOUT OU MODIFICATION DE PIÈCES

Des pièces supplémentaires ou modifiées qui ne sont pas acceptées par CARB ou EPA ne doivent pas être utilisées. L'utilisation de pièces supplémentaires ou modifiées non acceptées annule la garantie. Husqvarna Forest & Garden n'est pas responsable des pannes des pièces sous garantie si ces pannes sont causées par l'utilisation de pièces supplémentaires ou modifiées non acceptées.

DEMANDE D'INDEMNITÉ

Pour toute question relative à vos droits et responsabilités relativement à la garantie, communiquez avec le centre de services agréé le plus proche, appelez Husqvarna

Forest & Garden au CANADA au 1-800-805-5523, ou aux ÉTATS-UNIS au 1-800-487-5951, ou bien envoyez un courriel à l'adresse emissions@husqvarnagroup.com.

SERVICE APRÈS-VENTE

Les révisions ou réparations sous garantie sont disponibles auprès de tous les revendeurs agréés Husqvarna Forest & Garden.

ENTRETIEN, REMPLACEMENT ET RÉPARATION DES PIÈCES DU SYSTÈME DE LUTTE CONTRE LES ÉMISSIONS

Les pièces de rechange utilisées pour des travaux de maintenance ou de réparation couverts par la garantie ne doivent pas être débitées au propriétaire. Une telle utilisation ne réduit pas les obligations du fabricant en matière de garantie.

DÉCLARATION D'ENTRETIEN

L'utilisateur est chargé d'effectuer l'entretien prévu tel qu'il est défini dans le Manuel de l'utilisation.

*L'année modèle courante et suivante sera mise à jour annuellement dans la déclaration de garantie fournie au consommateur. Par exemple, 2012-2013 sera spécifié pour l'année modèle 2012.

KEY TO SYMBOLS

Symbols

WARNING! The machine can be a dangerous tool if used incorrectly or carelessly, which can cause serious or fatal injury to the operator or others. It is extremely important that you read and understand the contents of the operator's manual.



Please read the operator's manual carefully and make sure you understand the instructions before using the machine.



Always wear:

- Wear a protective helmet where there is a risk of falling objects
- Approved hearing protection
- Protective goggles or a visor



This machine is not electrically insulated. If the machine touches or comes close to high-voltage power lines it could lead to death or serious bodily injury. Electricity can jump from one point to another by arcing. The higher the voltage, the greater the distance electricity can jump. Electricity can also travel through branches and other objects, especially if they are wet. Always keep a distance of at least 10 m between the machine and high-voltage power lines and/or any objects that are touching them. If have to work within this safe distance you should always contact the relevant power company to make sure the power is switched off before you start work.

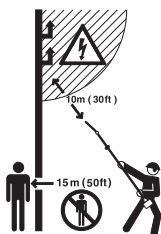

This machine has a long reach. Make sure that no people or animals come closer than 15 m when the machine is running.

Always wear approved protective gloves.



Wear sturdy, non-slip boots.



Choke control



Primer bulb

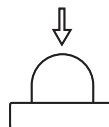

Other symbols/decals on the machine refer to special certification requirements for certain markets.

The engine is switched off by moving the stop switch to the stop position. **CAUTION!** The stop switch automatically returns to the start position. In order to prevent unintentional starting, the spark plug cap must be removed from the spark plug when assembling, checking and/or performing maintenance.

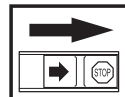

Always wear approved protective gloves.

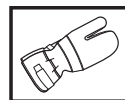

Regular cleaning is required.

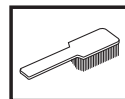

Visual check.



Protective goggles or a visor must be worn.



Filling with chain oil and adjusting oil flow



WARNING

The engine exhaust from this product contains chemicals known to the State of California to cause cancer, birth defects or other reproductive harm.

CONTENTS

Contents

KEY TO SYMBOLS

Symbols 61

CONTENTS

Contents 62

Note the following before starting: 62

INTRODUCTION

Dear customer! 63

WHAT IS WHAT?

What is what? 64

GENERAL SAFETY PRECAUTIONS

Important 65

Personal protective equipment 65

Machine's safety equipment 66

ASSEMBLY

Fitting the cutting head 75

Fitting the bar and chain 75

Fitting the impact guard 75

Telescopic function 76

Adjusting the harness 76

FUEL HANDLING

Fuel safety 77

Fuel 77

Fueling 78

STARTING AND STOPPING

Check before starting 79

Filling with oil 79

Starting and stopping 79

WORKING TECHNIQUES

General working instructions 81

MAINTENANCE

Carburetor 84

Muffler 84

Cooling system 84

Spark plug 85

Air filter 85

Gear 85

Maintenance schedule 86

TECHNICAL DATA

Technical data 87

FEDERAL AND CALIFORNIA EMISSIONS

CONTROL WARRANTY STATEMENT

YOUR WARRANTY RIGHTS AND OBLIGATIONS 88

Note the following before starting:

Please read the operator's manual carefully.

Maintenance, replacement, or repair of the emission control devices and system may be performed by any nonroad engine repair establishment or individual.



WARNING! Long-term exposure to noise can result in permanent hearing impairment. So always use approved hearing protection.



WARNING! Under no circumstances may the design of the machine be modified without the permission of the manufacturer. Always use genuine accessories. Non-authorized modifications and/or accessories can result in serious personal injury or the death of the operator or others.

Your warranty does not cover damage or liability caused by the use of non-authorized accessories or replacement parts.



WARNING! A pole saw is a dangerous tool if used carelessly or incorrectly and can cause serious, even fatal injuries. It is extremely important that you read and understand the contents of this Operator's Manual.

EMISSION CONTROL INFORMATION

 Husqvarna

HUSQVARNA AB HUSKVARNA SWEDEN

THIS ENGINE MEETS U.S. EPA AND CALIFORNIA EXH/EVP REGS FOR [] HOURS. REFER TO OPERATOR'S MANUAL FOR MAINTENANCE SPECIFICATIONS AND ADJUSTMENTS. EMISSIONS COMPLIANCE PERIOD: []

The Emissions Compliance Period referred to on the Emission Compliance label indicates the number of operating hours for which the engine has been shown to meet Federal and California emissions requirements.

INTRODUCTION

Dear customer!

Congratulations on your choice to buy a Husqvarna product! Husqvarna is based on a tradition that dates back to 1689, when the Swedish King Karl XI ordered the construction of a factory on the banks of the Huskvarna River, for production of muskets. The location was logical, since water power was harnessed from the Huskvarna River to create the water-powered plant. During over 300 years of continuous operation, the Husqvarna factory has produced a lot of different products, from wood stoves to modern kitchen appliances, sewing machines, bicycles, motorcycles etc. In 1956, the first motor driven lawn mowers appeared, followed by chain saws in 1959, and it is within this area Husqvarna is working today.

Today Husqvarna is one of the leading manufacturers in the world of forest and garden products, with quality as our highest priority. We develop, manufacture and market high quality motor driven products for forestry and gardening as well as for building and construction industry.

Your purchase gives you access to professional help with repairs and service whenever this may be necessary. If the retailer who sells your machine is not one of our authorized dealers, ask for the address of your nearest servicing dealer.

It is our wish that you will be satisfied with your product and that it will be your companion for a long time. Think of this operator's manual as a valuable document. By following its' content (using, service, maintenance etc) the life span and the second-hand value of the machine can be extended. If you ever lend or sell this machine, make sure that the borrower or buyer gets the operator's manual, so they will also know how to properly maintain and use it.

Thank you for using a Husqvarna product.

Husqvarna AB has a policy of continuous product development and therefore reserves the right to modify the design and appearance of products without prior notice.

WHAT IS WHAT?

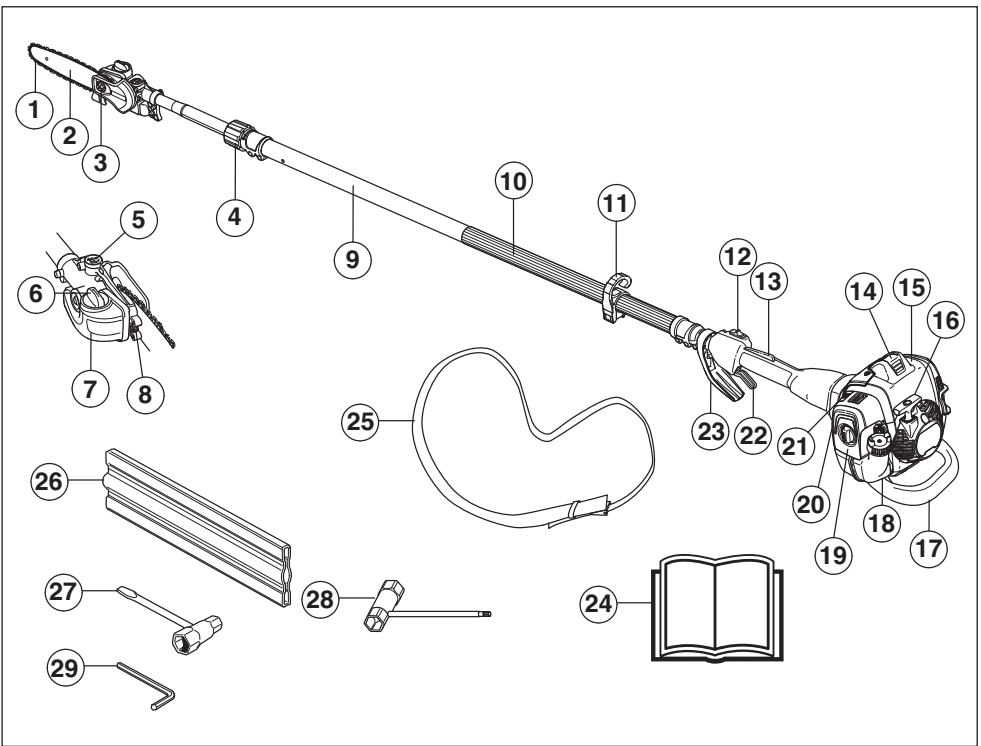

What is what?

- | | |
|--------------------------------------|--|
| 1 Saw chain | 16 Starter handle |
| 2 Guide bar | 17 Impact guard |
| 3 Bar nut | 18 Fuel tank |
| 4 Locking knob | 19 Air filter cover |
| 5 Chain lubrication adjustment screw | 20 Air purge |
| 6 Filling with chain oil | 21 Choke control |
| 7 Chain oil tank | 22 Throttle trigger |
| 8 Chain tensioning screw | 23 Throttle/hand guard |
| 9 Shaft | 24 Operator's manual |
| 10 Front handle | 25 Harness |
| 11 Harness support hook | 26 Transport guard, bar |
| 12 Stop switch | 27 Combination spanner Chain tensioner |
| 13 Throttle trigger lockout | 28 Combination spanner |
| 14 Spark plug cap and spark plug | 29 Allen key |
| 15 Cylinder cover | |

GENERAL SAFETY PRECAUTIONS

Important

IMPORTANT!

The machine is only designed for cutting branches and twigs.

National or local regulations may regulate the use. Comply to given regulations.

Never use a machine that has been modified in any way from its original specification.

Never use the machine if you are tired, if you have drunk alcohol, or if you are taking medication that could affect your vision, your judgement or your co-ordination.

Wear personal protective equipment. See instructions under the heading "Personal protective equipment".

Never use the machine in extreme weather conditions such as severe cold, very hot and/or humid climates.

Never use a machine that is faulty. Carry out the safety checks, maintenance and service instructions described in this manual. Some maintenance and service measures must be carried out by trained and qualified specialists. See instructions under the heading Maintenance.

All covers and guards must be fitted before starting. Ensure that the spark plug cap and ignition lead are undamaged to avoid the risk of electric shock.

Do an overall inspection of the machine before use, see maintenance schedule.



WARNING! This machine produces an electromagnetic field during operation. This field may under some circumstances interfere with active or passive medical implants. To reduce the risk of serious or fatal injury, we recommend persons with medical implants consult their physician and the medical implant manufacturer before operating this machine.



WARNING! Running an engine in a confined or badly ventilated area can result in death due to asphyxiation or carbon monoxide poisoning.



WARNING! Never allow children to use or be in the vicinity of the machine. As the machine is equipped with a spring-loaded stop switch and can be started by low speed and force on the starter handle, even small children under some circumstances can produce the force necessary to start the machine. This can mean a risk of serious personal injury. Therefore remove the spark plug cap when the machine is not under close supervision.

Personal protective equipment

IMPORTANT!

A pole saw is a dangerous tool if used carelessly or incorrectly and can cause serious, even fatal injuries. It is extremely important that you read and understand the contents of this Operator's Manual.

You must use approved personal protective equipment whenever you use the machine. Personal protective equipment cannot eliminate the risk of injury but it will reduce the degree of injury if an accident does happen. Ask your dealer for help in choosing the right equipment.



WARNING! Listen out for warning signals or shouts when you are wearing hearing protection. Always remove your hearing protection as soon as the engine stops.

PROTECTIVE HELMET AND VISOR

Protective helmet must be used.



HEARING PROTECTION

Wear hearing protection that provides adequate noise reduction.

EYE PROTECTION

Protective goggles or a visor must be worn.

GLOVES

Gloves should be worn when necessary, e.g., when fitting cutting attachments.



GENERAL SAFETY PRECAUTIONS

BOOTS

Wear sturdy, non-slip boots.



CLOTHING

Wear clothes made of a strong fabric and avoid loose clothing that can catch on twigs and branches. Always wear heavy, long pants. Do not wear jewellery, shorts sandals or go barefoot. Secure hair so it is above shoulder level.

FIRST AID KIT

Always have a first aid kit nearby.



Machine's safety equipment

This section describes the machine's safety equipment, its purpose, and how checks and maintenance should be carried out to ensure that it operates correctly. See the "What is what?" section to locate where this equipment is positioned on your machine.

The life span of the machine can be reduced and the risk of accidents can increase if machine maintenance is not carried out correctly and if service and/or repairs are not carried out professionally. If you need further information please contact your nearest servicing dealer.

IMPORTANT!

All servicing and repair work on the machine requires special training. This is especially true of the machine's safety equipment. If your machine fails any of the checks described below you must contact your service agent. When you buy any of our products we guarantee the availability of professional repairs and service. If the retailer who sells your machine is not a servicing dealer, ask him for the address of your nearest service agent.



WARNING! Never use a machine with faulty safety equipment. The machine's safety equipment must be checked and maintained as described in this section. If your machine fails any of these checks contact your service agent to get it repaired.

Throttle trigger lockout

The throttle lockout is designed to prevent accidental operation of the throttle control. When you press the lock (A) (i.e. when you grasp the handle) it releases the throttle control (B). When you release the handle the throttle control and the throttle lockout both move back to their original positions. This movement is controlled by two independent return springs. This arrangement means that the throttle control is automatically locked at the idle setting.

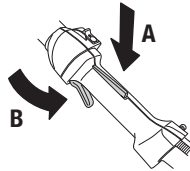

Make sure the throttle control is locked at the idle setting when the throttle lockout is released.

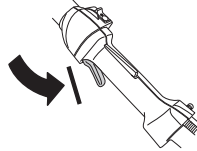

Press the throttle lockout and make sure it returns to its original position when you release it.

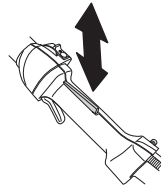

Check that the throttle trigger and throttle lockout move freely and that the return springs work properly.

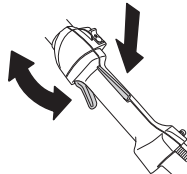

See instructions under the heading Start. Start the machine and apply full throttle. Release the throttle and check that the cutting attachment stops and remains at a standstill. If the cutting attachment rotates with the throttle in the idle position then the carburettor idle setting must

GENERAL SAFETY PRECAUTIONS

be checked. See instructions under the heading Maintenance.

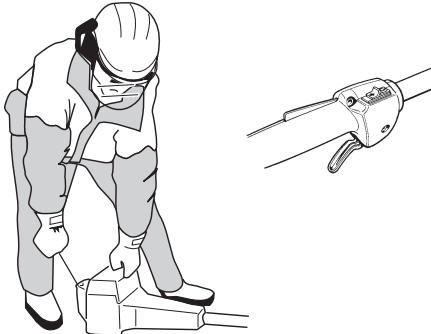

Stop switch

Use the stop switch to switch off the engine.

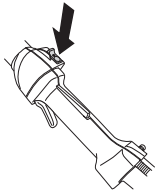

Start the engine and make sure the engine stops when you move the stop switch to the stop setting.

Vibration damping system



Your machine is equipped with a vibration damping system that is designed to reduce vibration and make operation easier.

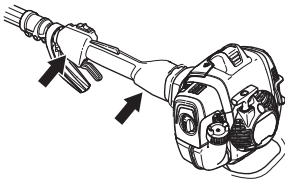

The machine's vibration damping system reduces the transfer of vibration between the engine unit/cutting equipment and the machine's handle unit.



WARNING! Overexposure to vibration can lead to circulatory damage or nerve damage in people who have impaired circulation. Contact your doctor if you experience symptoms of overexposure to vibration. Such symptoms include numbness, loss of feeling, tingling, pricking, pain, loss of strength, changes in skin colour or condition. These symptoms normally appear in the fingers, hands or wrists. The risk increases at low temperatures.

Muffler

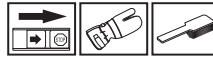

The muffler is designed to keep noise levels to a minimum and to direct exhaust fumes away from the user. A muffler fitted with a catalytic converter is also designed to reduce harmful exhaust gases.

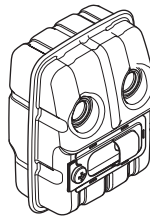

In countries that have a warm and dry climate there is a significant risk of fire. We therefore fit certain mufflers with a spark arrestor screen. Check whether the muffler on your machine is fitted with this kind of screen.

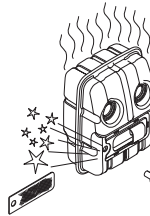

For mufflers it is very important that you follow the instructions on checking, maintaining and servicing your machine.

GENERAL SAFETY PRECAUTIONS

Never use a machine that has a faulty muffler.

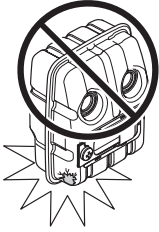

Regularly check that the muffler is securely attached to the machine.

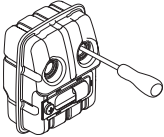

If the muffler on your machine is fitted with a spark arrestor screen this must be cleaned regularly. A blocked screen will cause the engine to overheat and may lead to serious damage.

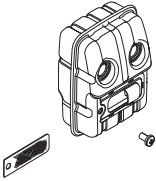

WARNING! Mufflers fitted with catalytic converters get very hot during use and remain so for some time after stopping. This also applies at idle speed. Contact can result in burns to the skin. Remember the risk of fire!



WARNING! The inside of the muffler contain chemicals that may be carcinogenic. Avoid contact with these elements in the event of a damaged muffler.



WARNING!

The exhaust fumes from the engine are hot and may contain sparks which can start a fire. Never start the machine indoors or near combustible material!

Cutting equipment



This section describes how you can achieve maximum clearing capacity and extend the life of the cutting attachment through correct maintenance and using the right type of cutting attachment.

- **Only use cutting equipment recommended by us!**

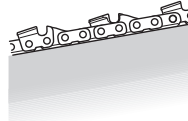

- **Keep the chain's cutting teeth properly sharpened! Follow our instructions and use the recommended file gauge.** A damaged or badly sharpened chain increases the risk of accidents.

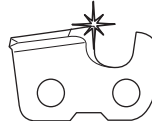

- **Maintain the correct raker clearance! Follow our instructions and use the recommended raker gauge.** Too large a clearance increases the risk of kickback.

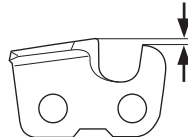

- **Keep the chain properly tensioned!** If the chain is slack it is more likely to jump off and lead to increased wear on the bar, chain and drive sprocket.



- **Keep cutting equipment well lubricated and properly maintained!** A poorly lubricated chain is more likely to break and lead to increased wear on the bar, chain and drive sprocket.



GENERAL SAFETY PRECAUTIONS



WARNING! Never use a machine with faulty safety equipment. The machine's safety equipment must be checked and maintained as described in this section. If your machine fails any of these checks contact your service agent to get it repaired.



WARNING! Always stop the engine before doing any work on the cutting attachment. This continues to rotate even after the throttle has been released. Ensure that the cutting attachment has stopped completely and disconnect the spark plug cap before you start to work on it.

Specification of bar and saw chain

When the cutting attachment supplied with your machine has to be replaced, because it is worn out or damaged, you must only fit the types of bar and saw chain recommended by us.

Guide bar

- Length (inches/cm)

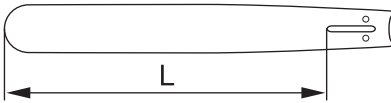

- Number of teeth on bar tip sprocket (T). Small number = small tip radius = low risk of kickback.

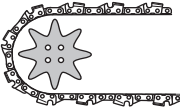

- Chain pitch (inches). The spacing between the drive links of the chain must match the spacing of the teeth on the bar tip sprocket and drive sprocket.

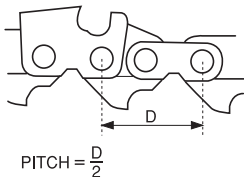

- Number of drive links. The number of drive links is determined by the length of the bar, the chain pitch and the number of teeth on the bar tip sprocket.

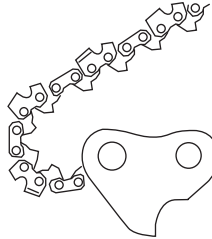

- Bar groove width (inches/mm). The groove in the bar must match the width of the chain drive links.

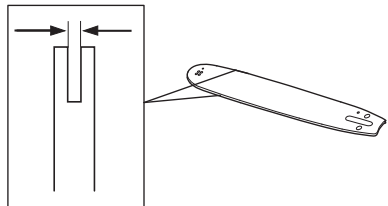

- Lubrication hole and hole for the chain tensioner.

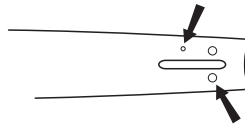

Saw chain

- Saw chain pitch (inches). (The distance between three drive links, divided by two.)

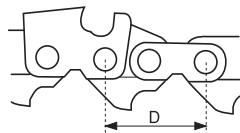

$$\text{PITCH} = \frac{D}{2}$$

- Drive link width (mm/inches)

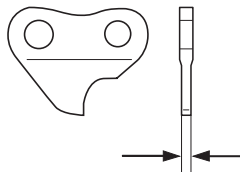

GENERAL SAFETY PRECAUTIONS

- Number of drive links.

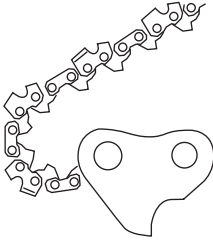

Level of kickback reduction. The only thing that describes the level of kickback reduction offered by a saw chain is its model number.

Sharpening your chain and adjusting raker clearance



WARNING! The risk of kickback is increased with a badly sharpened chain!

General information on sharpening cutting teeth



- Never use a blunt chain. When the chain is blunt you have to exert more pressure to force the bar through the wood and the cuttings will be very small. If the chain is very blunt it will not produce any cuttings at all. Wood powder would be the only result.
- A sharp chain eats its way through the wood and produces long, thick cuttings.
- The cutting part of the chain is called the cutting link and this consists of a cutting tooth (A) and the raker lip (B). The cutting depth is determined by the difference in height between the two.

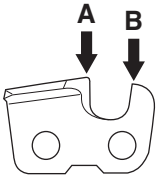

- When you sharpen a cutting tooth there are four important factors to remember.

- Filing angle

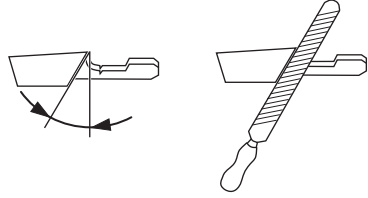

- Cutting angle

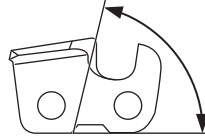

- File position

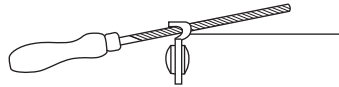

- Round file diameter

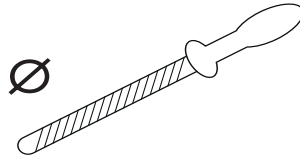

It is very difficult to sharpen a chain correctly without the right equipment. We recommend that you use our file gauge. This will help you obtain the maximum kickback reduction and cutting performance from your chain.

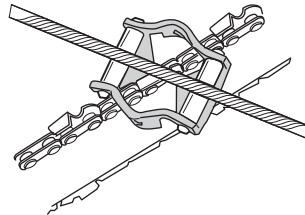

WARNING! Departure from the sharpening instructions considerably increases the risk of kickback.

GENERAL SAFETY PRECAUTIONS

Sharpening cutting teeth



To sharpen cutting teeth you will need a round file and a file gauge.

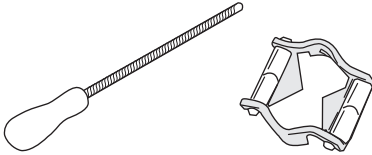

- Check that the chain is correctly tensioned. A slack chain will move sideways, making it more difficult to sharpen correctly.
- Always file cutting teeth from the inside face outwards. Reduce the pressure on the return stroke. File all the teeth on one side of the bar first. Then turn the saw over and file the remaining teeth from the other side.

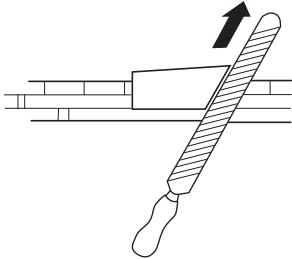

- File all the teeth to the same length. When the length of the cutting teeth is reduced to 5/32 inch (4 mm) the chain is worn out and should be replaced.

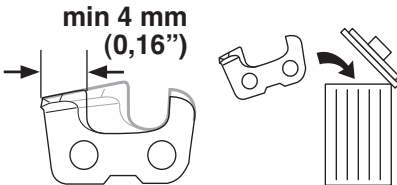

General advice on setting raker clearance



- When you sharpen the cutting teeth you reduce the raker clearance (=cutting depth). To maintain optimal cutting performance you must file back the raker lip to the recommended height.



- On a low-kickback cutting link the front edge of the raker lip is rounded. It is very important that you maintain this radius or bevel when you adjust the raker clearance.

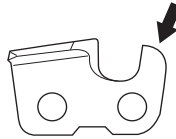

- We recommend that you use our raker gauge to achieve the correct clearance and bevel on the raker lip.

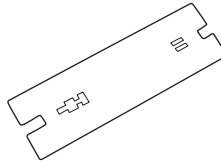

WARNING! The risk of kickback is increased if the raker clearance is too large!

Setting the raker clearance



- Before setting the raker clearance the cutting teeth should be newly sharpened.

We recommend that you adjust the raker clearance every third time you sharpen the chain. NOTE! This recommendation assumes that the length of the cutting teeth is not reduced excessively.

- To adjust the raker clearance you will need a flat file and a raker gauge.

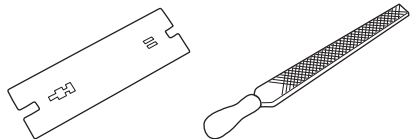

- Place the gauge over the raker lip.
- Place the file over the part of the lip that protrudes through the gauge and file off the excess. The clearance is correct when you no longer feel any resistance as you draw the file over the gauge.

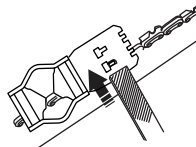

GENERAL SAFETY PRECAUTIONS

Tensioning the chain



WARNING! A slack chain may jump off the bar and cause serious or even fatal injury.

- The more you use a chain the longer it becomes. It is therefore important to adjust the chain regularly to take up the slack.
- Check the chain tension every time you refuel. **NOTE!** A new chain has a running-in period during which you should check the tension more frequently.
- Tension the chain as tightly as possible, but not so tight that you cannot pull it round freely by hand.

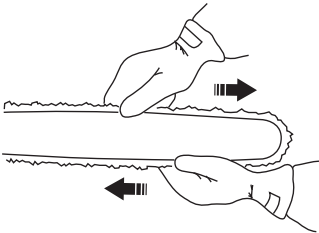

- Undo the bar nut.

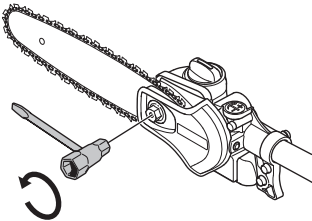

- Tension the chain by turning the chain tensioning screw clockwise using the combination spanner. The chain should be tensioned until it does not sag from the underside of the bar.

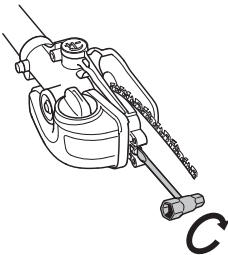

- Tighten the bar nut using the combination spanner. Check that the chain can be pulled round easily by hand.

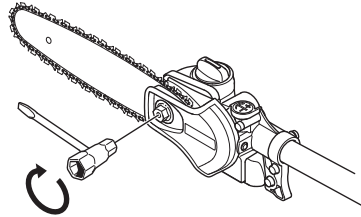

Lubricating cutting equipment



WARNING! Poor lubrication of cutting equipment may cause the chain to snap, which could lead to serious, even fatal injuries.

Chain oil

- Chain oil must demonstrate good adhesion to the chain and also maintain its flow characteristics regardless of whether it is warm summer or cold winter weather.
- As a chain saw manufacturer we have developed an optimal chain oil which has a vegetable oil base. We recommend the use of our own oil for both maximum chain life and to minimise environmental damage.
- If our own chain oil is not available, standard chain oil is recommended.
- In areas where oil specifically for lubrication of saw chains is unavailable, ordinary EP 90 transmission oil may be used.
- **Never use waste oil!** This is dangerous for yourself, the machine and the environment.

Filling with chain oil



The oil pump is preset at the factory to satisfy most lubrication requirements. A full oil tank normally lasts about the same time as a full fuel tank. Therefore check the amount of oil in the oil tank when filling the fuel to prevent damage to the saw chain and bar that may arise due to a lack of lubrication.

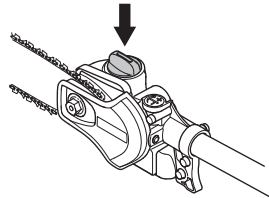

GENERAL SAFETY PRECAUTIONS

Checking chain lubrication

- Check the chain lubrication each time you refuel. Aim the tip of the bar at a light coloured surface about 20 cm (8 inches) away. After 1 minute running at 3/4 throttle you should see a distinct line of oil on the light surface.

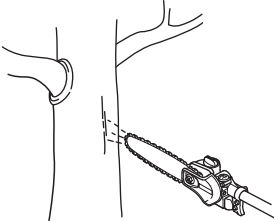

Adjusting chain lubrication

When cutting dry or hard species of wood it may be necessary to increase lubrication. Turn the adjuster screw clockwise to increase the oil flow. Remember that this will increase oil consumption, check the level in the oil tank regularly. Turn the adjuster screw anticlockwise to decrease the oil flow.

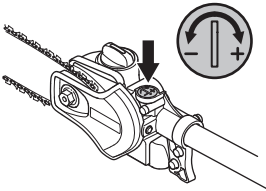

What to do if lubrication does not work:



- Check that the oil channels in the bar are not obstructed. Clean if necessary.

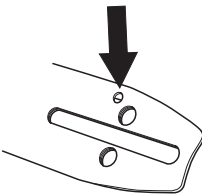

- Check that the oil channel in the gear housing is clean. Clean if necessary.
- Check that the bar tip sprocket turns freely. If the chain lubrication system is still not working after carrying out

the above checks you should contact your service workshop.

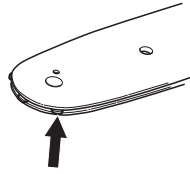

Checking wear on cutting equipment

Saw chain

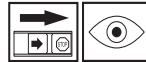

Check the chain daily for:

- Visible cracks in rivets and links.
- Whether the chain is stiff.
- Whether rivets and links are badly worn.

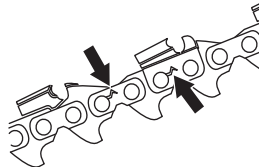

We recommend you compare the existing chain with a new chain to decide how badly the existing chain is worn.

When the length of the cutting teeth has worn down to only 5/32 inch (4 mm) the chain must be replaced.

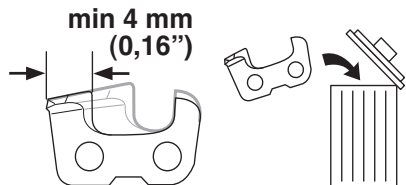

Chain drive sprocket



Regularly check the degree of wear on the drive sprocket. Replace if wear is excessive.

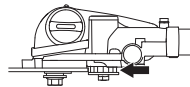

GENERAL SAFETY PRECAUTIONS

Guide bar



Check regularly:

- Whether there are burrs on the edges of the bar. Remove these with a file if necessary.

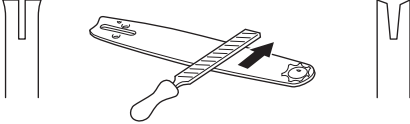

- Whether the groove in the bar has become badly worn. Replace the bar if necessary.
- Whether the tip of the bar is uneven or badly worn. If a hollow forms on the underside of the bar tip this is due to running with a slack chain.

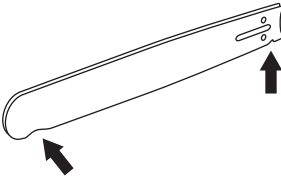

- To prolong the life of the bar you should turn it over daily.

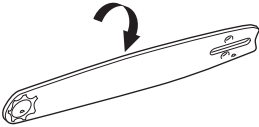

WARNING! A faulty cutting attachment may increase the risk of accidents.

ASSEMBLY

Fitting the cutting head



- Fit the cutting head on the shaft so that the screw (A) is aligned with the hole in the shaft as shown.

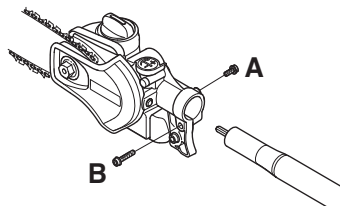

- Tighten screw A.
- Tighten screw B.

CAUTION! Make sure that the drive shaft inside the shaft engages with the cut-out in the cutting head.

Fitting the bar and chain



Unscrew the bar nut and remove the protective cover.

Fit the bar over the bar bolt. Place the bar in its rearmost position. Place the chain over the drive sprocket and in the groove on the bar. Begin on the top side of the bar. Make sure that the edges of the cutting links are facing forward on the top edge of the bar.

Fit the cover and locate the chain adjuster pin (A) in the hole in the bar. Check that the drive links of the chain fit correctly on the drive sprocket (B) and that the chain is in the groove in the bar. Tighten the bar nut finger-tight.

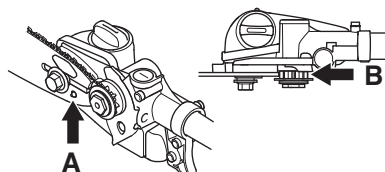

Tension the chain by turning the chain tensioning screw clockwise. Use a combination spanner or turn by hand.

The chain should be tensioned until it fits snugly on the underside of the bar.

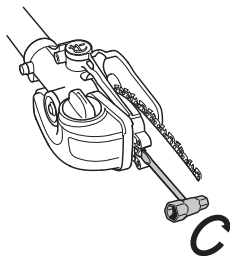

- The chain is correctly tensioned when there is no slack on the underside of the bar, and it can still be turned easily by hand. Tighten the bar nut with the combination spanner while holding up the tip of the bar.

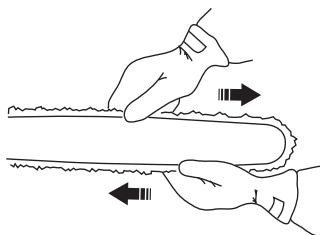

- When fitting a new chain, the chain tension has to be checked frequently until the chain is run-in. Check the chain tension regularly. A correctly tensioned chain ensures good cutting performance and long life.

Fitting the impact guard

If the machine has an impact guard bolted under the engine this should be removed before the impact guard is assembled.

Fit the guard with three screws. Tighten the screws to 4 Nm. After the machine has been in use for around 20 hours, re-tighten the screws to 4 Nm.

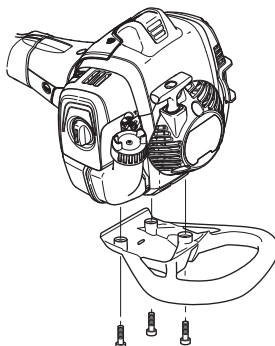

ASSEMBLY

Telescopic function



The shaft of the machine is telescopic. To change the length of the shaft, do the following:

- Undo the knob.

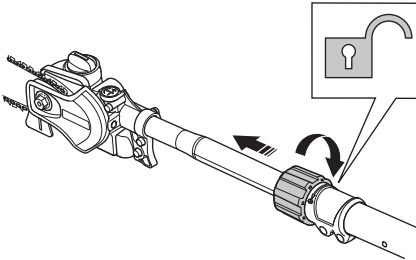

- Pull out the shaft to the desired length.
- Tighten the knob.

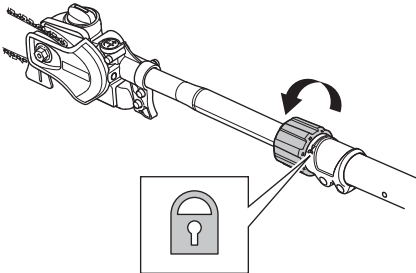

Adjusting the harness



You should always use the harness with the machine to give maximum control over the machine and reduce the risk of fatigue in your arms and back.

- Put on the harness.
- Hook the harness in one of the hooks on the machine.

- Adjust the length of the harness so that the support hook is roughly level with your right hip.



FUEL HANDLING

Fuel safety

Never start the machine:

- 1 If you have spilled fuel on it. Wipe off the spillage and allow remaining fuel to evaporate.
- 2 If you have spilled fuel on yourself or your clothes, change your clothes. Wash any part of your body that has come in contact with fuel. Use soap and water.
- 3 If the machine is leaking fuel. Check regularly for leaks from the fuel cap and fuel lines. In the event of leakage, contact your service agent.

Transport and storage

- Store and transport the machine and fuel so that there is no risk of any leakage or fumes coming into contact with sparks or open flames, for example, from electrical machinery, electric motors, electrical relays/switches or boilers.
- When storing and transporting fuel always use approved containers intended for this purpose.
- When storing the machine for long periods the fuel tank must be emptied. Contact your local gas station to find out where to dispose of excess fuel. Drain the tank into the appropriate containers and in a well ventilated area.
- Ensure the machine is cleaned and that a complete service is carried out before long-term storage.
- The transport guard must always be fitted to the cutting attachment when the machine is being transported or in storage.
- Secure the machine during transport.
- In order to prevent unintentional starting of the engine, the spark plug cap must always be removed during long-term storage, if the machine is not under close supervision and when performing all service measures.
- Allow the machine to cool before putting it in storage.



WARNING! Take care when handling fuel. Bear in mind the risk of fire, explosion and inhaling fumes.

Fuel

CAUTION! The machine is equipped with a two-stroke engine and must always be run using a mixture of gasoline and two-stroke engine oil. It is important to accurately measure the amount of oil to be mixed to ensure that the correct mixture is obtained. When mixing small amounts of fuel, even small inaccuracies can drastically affect the ratio of the mixture.



WARNING! Fuel and fuel fumes are highly inflammable and can cause serious injury when inhaled or allowed to come in contact with the skin. For this reason observe caution when handling fuel and make sure there is adequate ventilation.



WARNING! Always ensure there is adequate ventilation when handling fuel.

Gasoline



CAUTION! Always use a quality gasoline/oil mixture with an octane rating of at least 87 octane ((RON+MON)/2). If your machine is equipped with a catalytic converter (see chapter on Technical data) always use a good quality unleaded gasoline/oil mixture. Leaded gasoline will destroy the catalytic converter.

Use low-emission gasoline, also known as alkylate gasoline, if it is available.



Ethanol blended fuel, E10 may be used (max 10% ethanol blend). Using ethanol blends higher than E10 will create lean running condition which can cause engine damage.

This engine is certified to operate on unleaded gasoline.

- The lowest recommended octane grade is 87 ((RON+MON)/2). If you run the engine on a lower octane grade than 87 so-called knocking can occur. This gives rise to a high engine temperature and increased bearing load, which can result in serious engine damage.
- When working at continuous high revs a higher octane rating is recommended.

Two-stroke oil

- For best results and performance use HUSQVARNA two-stroke engine oil, which is specially formulated for our air-cooled two stroke-engines.
- Never use two-stroke oil intended for water-cooled engines, sometimes referred to as outboard oil (rated TCW).
- Never use oil intended for four-stroke engines.
- A poor oil quality and/or too high oil/fuel ratio may jeopardise function and decrease the life time of the catalytic converters.
- Mixing ratio
50:1 (2%) with HUSQVARNA two-stroke oil.

FUEL HANDLING

Gasoline, litre	Two-stroke oil, litre
	2% (50:1)
5	0,10
10	0,20
15	0,30
20	0,40
US gallon	US fl. oz.
1	2 1/2
2 1/2	6 1/2
5	12 7/8

Mixing

- Always mix the gasoline and oil in a clean container intended for fuel.
- Always start by filling half the amount of the gasoline to be used. Then add the entire amount of oil. Mix (shake) the fuel mixture. Add the remaining amount of gasoline.
- Mix (shake) the fuel mixture thoroughly before filling the machine's fuel tank.



- Do not mix more than one month's supply of fuel at a time.
- If the machine is not used for some time the fuel tank should be emptied and cleaned.



WARNING! The catalytic converter muffler gets very hot during and after use. This also applies during idling. Be aware of the fire hazard, especially when working near flammable substances and/or vapors.

Fueling



WARNING! Taking the following precautions, will lessen the risk of fire:

Mix and pour fuel outdoors, where there are no sparks or flames.

Do not smoke or place hot objects near fuel.

Always shut off the engine before refueling.

Always stop the engine and let it cool for a few minutes before refueling. Refuel in a well ventilated area. Never fuel the machine indoors.

When refuelling, open the fuel cap slowly so that any excess pressure is released gently.

Tighten the fuel cap carefully after refueling.

Always move the machine away from the refueling area and source before starting.

- Always use a fuel container with an anti-spill valve.
- If you have spilled fuel on it. Wipe off the spillage and allow remaining fuel to evaporate.
- Clean the area around the fuel cap. Contamination in the tank can cause operating problems.
- Ensure that the fuel is well mixed by shaking the container before filling the tank.

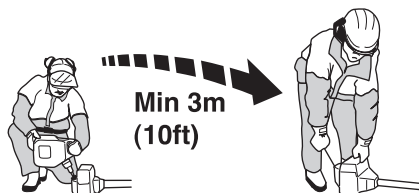

STARTING AND STOPPING

Check before starting



- Inspect the working area. Remove any objects that could be thrown out.
- Check the cutting attachment. Never use blunt, cracked or damaged equipment.
- Check that the machine is in perfect working order. Check that all nuts and screws are tight.
- Make sure the chain is adequately lubricated.
- Check that the cutting attachment always stops when the engine is idling.
- Only use the machine for the purpose it was intended for.
- Make sure that the handle and safety features are in good working order. Never use a machine that lacks a part or has been modified outside its specifications.

Filling with oil



- Open the cap on top of the bar head

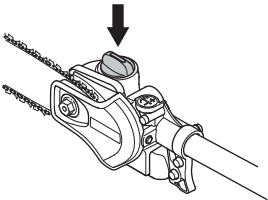

- Fill with Husqvarna saw chain oil.
- Refit the cap.

Starting and stopping



WARNING! The complete clutch cover and shaft must be fitted before the machine is started, otherwise the clutch can come loose and cause personal injury.

Always move the machine away from the refueling area and source before starting. Place the machine on a flat surface. Ensure the cutting attachment cannot come into contact with any object. Make sure no unauthorised persons are in the working area, otherwise there is a risk of serious personal injury. The safety distance is 15 meters (50 ft.).

Starting



Primer bulb: Press the air purge repeatedly until fuel begins to fill the bulb. The bulb need not be completely filled.

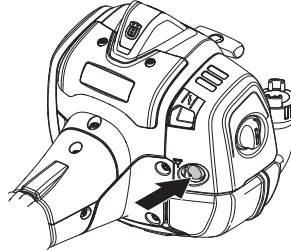

Choke: Set the choke control in the choke position.

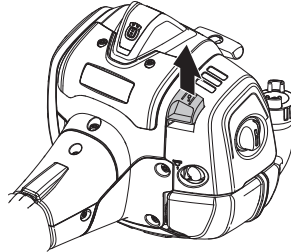

WARNING! When the engine is started with the choke in choke position the cutting attachment will start to rotate immediately.

Hold the body of the machine on the ground using your left hand (CAUTION! Not with your foot!). Grip the starter handle, slowly pull out the cord with your right hand until you feel some resistance (the starter pawls grip), now quickly and powerfully pull the cord. **Never wrap the starter cord around your hand**

Repeat pulling the cord until engine attempts to start (or maximum 5 pulls).

Move choke control down to run position.

Pull the cord until engine starts and gradually operate throttle trigger for increasing engine speed to operate speed. The throttle will automatically disengage from the start setting.

STARTING AND STOPPING

CAUTION! Do not pull the starter cord all the way out and do not let go of the starter handle when the cord is fully extended. This can damage the machine.



CAUTION! Do not put any part of your body in marked area. Contact can result in burns to the skin, or electrical shock if the spark plug cap has been damaged. Always use gloves. Do not use a machine with damaged spark plug cap.

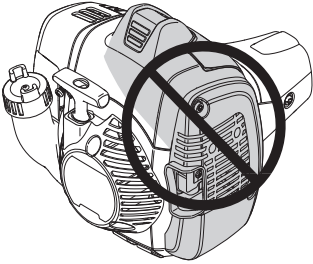

Stopping

Stop the engine by switching off the ignition.

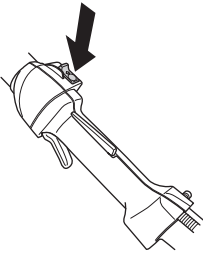

CAUTION! The stop switch automatically returns to the start position. In order to prevent unintentional starting, the spark plug cap must be removed from the spark plug when assembling, checking and/or performing maintenance.

WORKING TECHNIQUES

General working instructions

IMPORTANT!

This section takes up the basic safety precautions for working with a pole saw.

If you encounter a situation where you are uncertain how to proceed you should ask an expert. Contact your dealer or your service workshop.

Avoid all usage which you consider to be beyond your capability.



WARNING! The machine can cause serious personal injury. Read the safety instructions carefully. Learn how to use the machine.



WARNING! Cutting tool. Do not touch the tool without first switching off the engine.

Personal protection



- Always wear boots and other equipment described under the heading Personal protective equipment.
- Always wear working clothes and heavy-duty long trousers.
- Never wear loose clothing or jewellery.
- Make sure your hair does not hang below shoulder level.

Safety instructions regarding the surroundings

- Never allow children to use the machine.
- Ensure that no-one comes closer than 15 m while you are working.
- Never allow anyone else to use the machine without first ensuring that they have read and understood the contents of the operator's manual.

- Never work from a ladder, stool or any other raised position that is not fully secured.

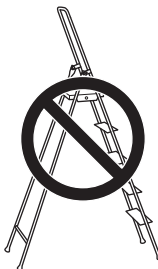

Safety instructions while working



- Always ensure you have a safe and stable working position.
- Always use both hands to hold the machine. Hold the machine at the side of your body.



- Use your right hand to control the throttle setting.
- Make sure that your hands and feet do not come near the cutting attachment when the engine is running.
- When the engine is switched off, keep your hands and feet away from the cutting attachment until it has stopped completely.
- Always lay the machine on the ground when you are not using it.
- Watch out for stumps of branches that can be thrown out during cutting.
- You should also pay attention to the fact that falling branches can bounce in the direction of the user after hitting the ground.
- Check the working area for foreign objects such as electricity cables, insects and animals, etc, or other objects that could damage the cutting attachment, such as metal items.

WORKING TECHNIQUES

- Use the harness to support the weight of the machine and make it easier to handle.



- If any foreign object is hit or if vibrations occur stop the machine immediately. Disconnect the HT lead from the spark plug. Check that the machine is not damaged. Repair any damage.
- If anything gets caught up in the cutting equipment while you are working, switch off the engine and let it stop completely and remove the ignition lead before cleaning the cutting equipment.
- This machine is not electrically insulated. If the machine touches or comes close to high-voltage power lines it could lead to death or serious bodily injury.

Safety instructions after completing work



- The transport guard should always be fitted to the cutting attachment when the machine is not in use.
- Make sure the cutting attachment has stopped before cleaning, carrying out repairs or an inspection. Disconnect the spark plug cap from the spark plug.
- Always wear heavy-duty gloves when repairing the cutting attachment. This is extremely sharp and can easily cause cuts.

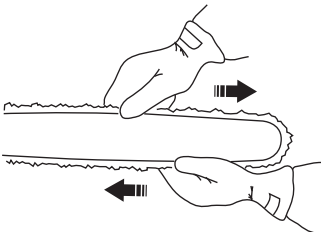

- Store the machine out of reach of children.
- Use only original spare parts for repairs.

Basic working techniques

- Hold the machine as close to your body as possible to get the best balance.



- Make sure that the tip does not touch the ground.
- Do not rush the work, but work steadily until all the branches have been cut back cleanly.
- Always slow the engine to idle speed after each working operation. Long periods at full throttle without any load on the engine can lead to serious engine damage.
- Always work at full throttle.
- Let the engine drop back to idle speed between each cut. Long periods at full throttle can cause serious damage to the centrifugal clutch.



WARNING! Never stand directly underneath a branch that is being cut. This could lead to serious or even fatal personal injury.

Observe great care when working close to overhead power lines. Falling branches can result in short-circuiting.



WARNING! Observe the applicable safety regulations for work in the vicinity of overhead power lines.

WORKING TECHNIQUES



WARNING! This machine is not electrically insulated. If the machine touches or comes close to high-voltage power lines it could lead to death or serious bodily injury. Electricity can jump from one point to another by arcing. The higher the voltage, the greater the distance electricity can jump. Electricity can also travel through branches and other objects, especially if they are wet. Always keep a distance of at least 10 m between the machine and high-voltage power lines and/or any objects that are touching them. If have to work within this safe distance you should always contact the relevant power company to make sure the power is switched off before you start work.



WARNING! This machine has a long reach. Make sure that no people or animals come closer than 15 m when the machine is running. Never swing the machine around without first checking behind you to make sure no-one is within the safety zone.

- Whenever possible position yourself so that you can make the cut at right angles to the branch.

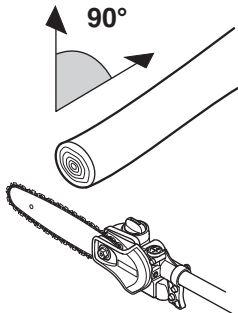

- Do not work with the shaft held straight out in front of you (like a fishing rod) as this increases the apparent weight of the cutting attachment.
- Cut large branches in sections so that you have better control over where they fall.

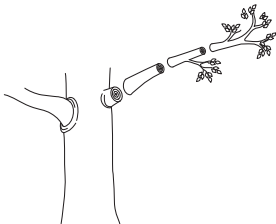

- Never cut through the swelling at the root of the branch as this will slow down healing and increase the risk of fungal attack!

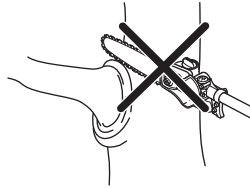

- Make an initial cut on the underside of the branch before cutting through the branch. This will prevent tearing of the bark, which could lead to slow healing and cause permanent damage to the tree. The cut should not be deeper than 1/3 of the branch thickness to prevent jamming. Keep the chain running while you withdraw the cutting attachment from the branch to prevent it jamming.

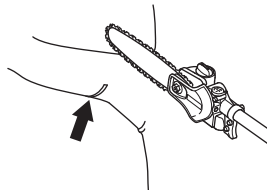

- Use the harness to support the weight of the machine and make it easier to handle.



- Make sure you have a firm footing and that you can work without being hampered by branches, stones and trees.



WARNING! Never activate the throttle without having the cutting attachment in full view.

MAINTENANCE

Carburetor

Adjustment of the idle speed

Before any adjustments are made, make sure that the air filter is clean and the air filter cover is fitted.

Adjust the idle speed using the idle adjustment screw T, if it is necessary to readjust. First turn the idle adjustment screw T clockwise until the cutting attachment starts to rotate. Then turn the screw counter clockwise until the cutting attachment stops. The idle speed is correctly adjusted when the engine will run smoothly in every position. The idle speed should also be well below the speed at which the cutting attachment starts to rotate.

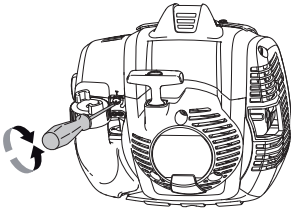

Recommended idle speed: See the Technical data section.



WARNING! If the idle speed cannot be adjusted so that the cutting attachment stops, contact your dealer/service workshop. Do not use the machine until it has been correctly adjusted or repaired.

Muffler



CAUTION! Some mufflers are fitted with a catalytic converter. See chapter on Technical data to see whether your machine is fitted with a catalytic converter.

The muffler is designed to reduce the noise level and to direct the exhaust gases away from the operator. The exhaust gases are hot and can contain sparks, which may cause fire if directed against dry and combustible material.

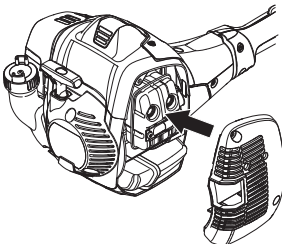

Some mufflers are equipped with a special spark arrester screen. If your machine has this type of muffler, you should clean the screen at least once a week. This is best done with a wire brush.



On mufflers without a catalytic converter the screen should be cleaned weekly, or replaced if necessary. On mufflers fitted with a catalytic converter the screen should be checked, and if necessary cleaned, monthly. **If the screen is damaged it should be replaced.**

If the screen is frequently blocked, this can be a sign that the performance of the catalytic converter is impaired. Contact your dealer to inspect the muffler. A blocked screen will cause the machine to overheat and result in damage to the cylinder and piston. See instructions under the heading Maintenance.

CAUTION! Never use a machine with a defective muffler.



WARNING! Mufflers fitted with catalytic converters get very hot during use and remain so for some time after stopping. This also applies at idle speed. Contact can result in burns to the skin. Remember the risk of fire!

Cooling system

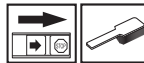

To keep the working temperature as low as possible the machine is equipped with a cooling system.

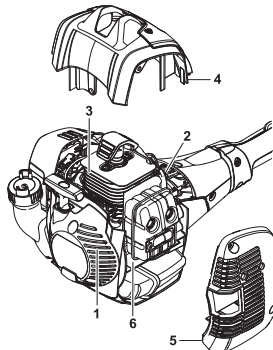

The cooling system consists of:

- 1 Air intake on the starter.

MAINTENANCE

- 2 Fins on the flywheel.
- 3 Cooling fins on the cylinder.
- 4 Cylinder cover (directs cold air over the cylinder).

Clean the cooling system with a brush once a week, more often in demanding conditions. A dirty or blocked cooling system results in the machine overheating which causes damage to the piston and cylinder.

Spark plug



The spark plug condition is influenced by:

- Incorrect carburetor adjustment.
- An incorrect fuel mixture (too much or incorrect type of oil).
- A dirty air filter.

These factors cause deposits on the spark plug electrodes, which may result in operating problems and starting difficulties.

If the machine is low on power, difficult to start or runs poorly at idle speed: always check the spark plug first before taking any further action. If the spark plug is dirty, clean it and check that the electrode gap is 0.026 inch (0.65 mm). The spark plug should be replaced after about a month in operation or earlier if necessary.

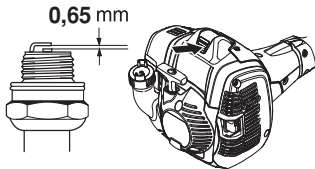

CAUTION! Always use the recommended spark plug type! Use of the wrong spark plug can damage the piston/cylinder. Check that the spark plug is fitted with a suppressor.

Air filter



The air filter must be regularly cleaned to remove dust and dirt in order to avoid:

- Carburetor malfunctions.
- Starting problems.
- Loss of engine power.
- Unnecessary wear to engine parts
- Excessive fuel consumption.

Clean the filter every 25 hours, or more regularly if conditions are exceptionally dusty.

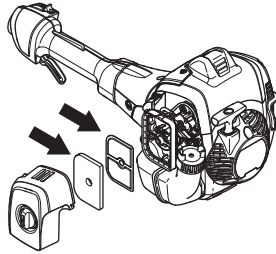

Cleaning the air filter

Close the choke valve by moving the choke control up.

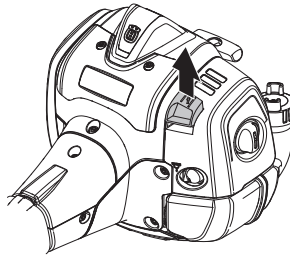

Remove the air filter cover and take out the filter. Wash it clean in warm, soapy water.

IMPORTANT! Use only HUSQVARNA replacement parts. Use of other brands of replacement parts can cause damage to your unit or injury to the operator or others. Your warranty does not cover damage or liability caused by the use of accessories and/or attachments not specifically recommended by HUSQVARNA.

Gear

IMPORTANT!

All service on the saw head must be carried out by an authorized Husqvarna dealer.

Always use Husqvarna's original grease to prevent damage to the gear in the saw head.

Use grease with part number: 579 06 49-01

MAINTENANCE

Maintenance schedule

The following is a list of the maintenance that must be performed on the machine. Most of the items are described in the Maintenance section. The user must only carry out the maintenance and service work described in this manual. More extensive work must be carried out by an authorized service workshop.

Maintenance	Daily Maintenance	Weekly maintenance	Monthly maintenance
Clean the outside of the machine.	X		
Make sure the throttle trigger lock and the throttle function correctly from a safety point of view.	X		
Check that the stop switch works correctly.	X		
Check that the cutting attachment does not rotate at idle.	X		
Clean the air filter. Replace if necessary.	X		
Check that nuts and screws are tight.	X		
Check that there are no fuel leaks from the engine, tank or fuel lines.	X		
Clean the area under the protective cover.	X		
Check the saw chain with regard to visible cracks in the rivets and links, whether the saw chain is stiff or whether the rivets and links are abnormally worn.	X		
Check the starter and starter cord.		X	
Check that the vibration damping elements are not damaged.		X	
Clean the outside of the spark plug. Remove it and check the electrode gap. Adjust the gap to 0.65 mm (.026"), or replace the spark plug. Check that the spark plug is fitted with a suppressor.		X	
Clean the machine's cooling system.		X	
Clean or replace the spark arrestor screen on the muffler (only applies to mufflers without a catalytic converter).		X	
Clean the outside of the carburettor and the space around it.		X	
File off any burrs from the edges of the bar.		X	
Clean the fuel tank.			X
Check the fuel filter for contamination and the fuel hose for cracks or other defects. Replace if necessary.			X
Check all cables and connections.			X
Check the clutch, clutch springs and the clutch drum for wear. Replace if necessary by an authorized service workshop.			X
Replace the spark plug. Check that the spark plug is fitted with a suppressor.			X
Check and clean the spark arrestor screen on the muffler (only applies to mufflers fitted with a catalytic converter).			X

TECHNICAL DATA

Technical data





	525PT5S
Engine	
Cylinder displacement, cu.in/cm ³	1,55/25,4
Cylinder bore, inch/mm	1,34/34
Stroke, inch/mm	1,10/28
Recommended max. speed, rpm	11000-12000
Idle speed, rpm	2800-3000
Max. engine output, acc. to ISO 8893, kW/ rpm	1.0/8500
Catalytic converter muffler	Yes
Speed-regulated ignition system	Yes
Ignition system	
Spark plug	NGK BPMR8Y
Electrode gap, inch/mm	0.02/0,5
Fuel and lubrication system	
Fuel tank capacity, US pint/litre	1,06/0,5
Oil tank capacity, US pint/litre	0,30/0,14
Weight	
Weight without fuel, oil and cutting equipment, kg	16/7,2
Sound levels	
(see note 1)	
Equivalent sound pressure level at the operator's ear, measured according to ISO 22868, dB(A):	
	89
Vibration levels	
(see note 2)	
Vibration levels at handles, measured according to EN ISO 22867, m/s ²	
Short shaft front/rear handle	6,3/5,3
Extended shaft front/rear handle	4,1/6,7

Note 1: Reported data for equivalent sound pressure level for the machine has a typical statistical dispersion (standard deviation) of 1 dB (A).

Note 2: Reported data for equivalent vibration level has a typical statistical dispersion (standard deviation) of 1 m/s².

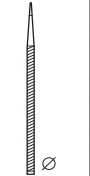
Guide bar and saw chain combinations

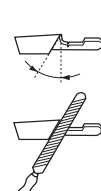
Guide bar			Saw chain	
Length, inch	Pitch, inch/mm	Gauge, inch	Type	Drive link count
12	3/8	0.050	H35	44

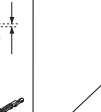
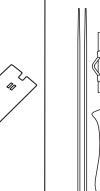
							
35	inch/mm 5/32 / 4,0	80°	30°	0°	inch/mm 0.025/0.65	—	5796536-01

FEDERAL AND CALIFORNIA EMISSIONS CONTROL WARRANTY STATEMENT

IMPORTANT: This product is compliant with U.S. EPA Phase 3 regulations for exhaust and evaporative emissions. To ensure EPA Phase 3 compliance, we recommend using only genuine Husqvarna brand replacement parts. Use of non-compliant replacement parts is a violation of federal law.

YOUR WARRANTY RIGHTS AND OBLIGATIONS

The EPA (U.S. Environmental Protection Agency), CARB (California Air Resources Board), Environment Canada and Husqvarna Forest & Garden are pleased to explain the emissions control system's warranty on your 2015-2016* small off-road engine. In U.S. and Canada, new equipment that use small off-road engines must be designed, built, and equipped to meet the applicable Federal or Californian stringent anti-smog standards. Husqvarna Forest & Garden must warrant the emissions control system on your small off-road engine for the period of time listed below provided there has been no abuse, neglect or improper maintenance of your small off-road engine. Your emission control system may include parts such as the carburetor, fuel-injection system, the ignition system, catalytic convertor, fuel tanks, fuel lines, fuel caps, valves, canisters, filters, vapor hoses, clamps, connectors, and other associated emission-related components. Also, included may be hoses, belts, connectors, sensors, and other emission-related assemblies. Where a warrantable condition exists, Husqvarna Forest & Garden will repair your small off-road engine at no cost to you including diagnosis, parts and labor.

MANUFACTURER'S WARRANTY COVERAGE

The emissions control system is warranted for two years. If any emissions-related part on your small off-road engine is defective, the part will be repaired or replaced by Husqvarna Forest & Garden.

OWNER'S WARRANTY RESPONSIBILITIES

- As the small off-road engine owner, you are responsible for performance of the required maintenance listed in your operator's manual. Husqvarna Forest & Garden recommends that you retain all receipts covering maintenance on your small off-road engine, but Husqvarna Forest & Garden cannot deny warranty solely for the lack of receipts or your failure to ensure the performance of all scheduled maintenance.
- As the small off-road engine owner, you should however be aware that Husqvarna Forest & Garden may deny you warranty coverage if your small off-road engine or a part has failed due to abuse, neglect, or improper maintenance or unapproved modifications.

- You are responsible for presenting your small off-road engine to a Husqvarna Forest & Garden distribution center or service center as soon as the problem exists. The warranty repairs should be completed in a reasonable amount of time, not to exceed 30 days.

If you have any questions regarding your warranty coverage, you should contact Husqvarna Forest & Garden in USA at 1-800-487-5951, in CANADA at 1-800-805-5523 or send e-mail correspondence to emissions@husqvarnagroup.com.

WARRANTY COMMENCEMENT DATE

The warranty period begins on the date the engine or equipment is delivered to an ultimate purchaser.

LENGTH OF COVERAGE

Husqvarna Forest & Garden warrants to the ultimate purchaser and each subsequent owner that the engine or equipment is designed, built, and equipped so as to conform with all applicable regulations adopted by EPA and CARB, and is free from defects in materials and workmanship that causes the failure of a warranted part for a period of two years.

WHAT IS COVERED

REPAIR OR REPLACEMENT OF PARTS Repair or replacement of any warranted part under the warranty must be performed at no charge to the owner at a warranty station. Warranty services or repairs will be provided at all Husqvarna Forest & Garden distribution centers that are franchised to service the subject engines. Throughout the emissions warranty period of two years, Husqvarna Forest & Garden must maintain a supply of warranted parts sufficient to meet the expected demand for such parts.

WARRANTY PERIOD Any warranted part that is scheduled for replacement as required in the maintenance schedule, is warranted for the period of time prior to the first scheduled replacement point for that part. If the part fails prior to the first scheduled replacement, the part will be repaired or replaced by Husqvarna Forest & Garden at no cost. Any such part repaired or replaced under warranty is warranted for the remainder of the period prior to the first scheduled replacement point for the part. Any warranted part that is not scheduled for replacement as required in the maintenance schedule, is warranted for two years. If any such part fails during the period of warranty coverage, it will be repaired and replaced by Husqvarna Forest & Garden at no cost. Any such part repaired or replaced under the warranty is warranted for the remaining warranty period. Any warranted part that is scheduled only for regular inspection in the maintenance schedule will be warranted for a period of two years. A statement in such written instructions to the effect of "repair or replace as necessary" will not reduce the period of warranty coverage. Any such part repaired or replaced under warranty will be warranted for the remaining warranty period.

FEDERAL AND CALIFORNIA EMISSIONS CONTROL WARRANTY STATEMENT

DIAGNOSIS The owner must not be charged for diagnostic labor that leads to the determination that a warranted part is in fact defective, provided that such diagnostic work is performed at a warranty station.

CONSEQUENTIAL DAMAGES Husqvarna Forest & Garden is liable for damages to other engine components proximately caused by a failure under warranty of any warranted part.

EMISSION WARRANTY PARTS LIST

- 1 Carburetor and internal parts
- 2 Intake pipe, airfilter holder and carburetor bolts.
- 3 Airfilter and fuelfilter covered up to maintenance schedule.
- 4 Spark Plug, covered up to maintenance schedule
- 5 Ignition Module
- 6 Fuel tank, line and cap

WHAT IS NOT COVERED

All failures caused by abuse, neglect or improper maintenance are not covered.

ADD -ON OR MODIFIED PARTS

Add-on or modified parts that are not exempted by CARB or EPA may not be used. The use of any non-exempted add-on or modified parts will be grounds for disallowing a warranty claim. Husqvarna Forest & Garden will not be liable to warrant failures of warranted parts caused by the use of a non-exempted add-on or modified part.

HOW TO FILE A CLAIM

If you have any questions regarding your warranty rights and responsibilities, you should contact your nearest authorized servicing dealer or call Husqvarna Forest & Garden in USA at 1-800-487-5951, in CANADA at 1-800-805-5523 or send e-mail correspondence to emissions@husqvarnagroup.com.

WHERE TO GET WARRANTY SERVICE

Warranty services or repairs are provided through all Husqvarna Forest & Garden authorized servicing dealers.

MAINTENANCE, REPLACEMENT AND REPAIR OF EMISSION-RELATED PARTS

Any replacement part may be used in the performance of any warranty maintenance or repairs and must be provided without charge to the owner. Such use will not reduce the warranty obligations of the manufacturer.

MAINTENANCE STATEMENT

The owner is responsible for the performance of all required maintenance, as defined in the operator's manual.

*Current and following model year will be updated annually in the warranty statement provided to the consumer. For example, in 2012 model year, 2012-2013 will be specified.

**Original instructions
Instructions d'origine
Original instructions**

1157426-49



2015-11-30